



SYSTEMS

of quality

SURGICAL INSTRUMENTS



+92 321 610 1708



systemsofquality@gmail.com



www.systemsofquality.com



SIALKOT-PAKISTAN

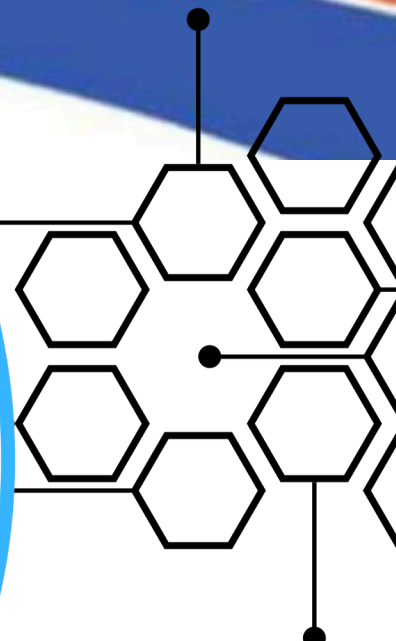



MEASUREMENT CONVERSION TABLES

INCHES TO CENTIMETERS		INCHES TO MILLIMETERS	
INCHES	CM	INCHES	MM
0.5	1.27	0.5	12.70
1	2.54	1	25.40
1.5	3.81	1.5	38.10
2	5.08	2	50.80
2.5	6.35	2.5	63.50
3	7.62	3	76.20
3.5	8.89	3.5	88.90
4	10.16	4	101.60
4.5	11.43	4.5	114.30
5	12.70	5	127.00
5.5	13.97	5.5	139.70
6	15.24	6	152.40
6.5	16.51	6.5	165.10
7	17.78	7	177.80
7.5	19.05	7.5	190.50
8	20.32	8	203.20
8.5	21.59	8.5	215.90
9	22.86	9	228.60
9.5	24.13	9.5	241.30
10	25.40	10	254.00
10.5	26.67	10.5	266.70
11	27.94	11	279.40
11.5	29.21	11.5	292.10
12	30.48	12	304.80
12.5	31.75	12.5	317.50
13	33.02	13	330.20
13.5	34.29	13.5	342.90
14	35.56	14	355.60
14.5	36.83	14.5	368.30
15	38.10	15	381.00



TABLE OF CONTENTS

Diagnostic Instruments.....	1-4
Scalpel Blades and Handles .	5-6
Operating Scissors.....	7-18
Operating Scissors Tungsten Carbide.....	19-24
Super-Cut Scissors.....	25-32
Plaster Cast Instruments.....	33
Bandage Scissors.....	34, 35
Cast Shears.....	36
Cast Instruments.....	37
Suture Scissors.....	38, 39
Hemostatic Forceps.....	40-49
Sponge Holding Forceps.....	50, 51
Towel Clamps.....	52, 53
Tube Occluding Clamps.....	54, 55
Needle Holders.....	56-62
Needle Holders, T.C.....	63-68
Dressing Forceps.....	69
Tissue Forceps.....	70, 71
Dressing and Tissue Forceps.....	72-77
Atraumatic and Cardiovascular Instruments.....	78, 79
Thoracic Cardiovascular Instruments.....	80, 81
Splinter Forceps.....	82, 83
Intestinal Instruments.....	84-87
Micro Surgery Instruments.....	88-90
ENT Instruments.....	91-93
Retractors.....	94-103
Tracheal Instruments.....	104-105
Suction Tubes.....	106
Neurosurgical Instruments.....	107-114
Orthopedic Instruments.....	115-126
Wire and Pin Cutters.....	127-129
Wire Cutters and Pullers Pliers.....	130-132
Pin and Rod End and Side Cutters.....	133-135
Gynecological Instruments.....	136-166

TABLE OF CONTENTS

Dermal Podiatry Instruments	167-168
Veterinary Spay Instruments	169
Cervical and Uterine Instruments	170, 171
Cannula Instruments and Parts	172
Grasping Forceps and S-Shaped Retractors	173
Instrument for Hystero-Salpingography	174
Laryngoscopes Standard	175-179
Laryngoscopes Fiber-Optic	180-186
Loop Instruments	187-200
Bi-Polar Forceps	201-202
Bariatric Surgical Instruments	203-227
Instrument Cleaning Solutions	228
Holloware Healthcare Products	229-248
Numerical Index	249-256
Numerical Index	257-264



19-260
19-265

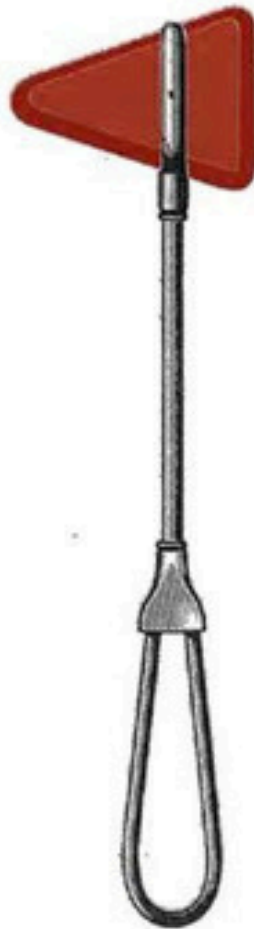

19-267



19-269



19-270

DIAGNOSTIC INSTRUMENTS

- 19-260 TAYLOR Percussion Hammer, Pediatric Size, Solid Handle, 7" (17.8 cm)
- 19-265 TAYLOR Percussion Hammer, Standard Size, Solid Handle, Chrome, 7½" (19.1 cm)
- 19-267 TAYLOR Percussion Hammer, Large Head, Loop Handle, Chrome, 9" (22.9 cm)
- 19-269 DEJERINE Percussion Hammer, Chrome, 9½" (24.1 cm)
- 19-270 TROMNER Percussion Hammer, With Large and Small Rubber Tips, Chrome, 9¾" (24.8 cm)



19-273



19-275



1021-210
1021-212



110-200

DIAGNOSTIC INSTRUMENTS

- 19-273 BUCK Neurological Hammer, With Brush and Needle, Chrome, 7 $\frac{1}{4}$ " (19.7 cm)
- 19-275 RABINER Neurological Hammer, With Brush and Needle, Chrome, 9" (22.9 cm)
- 1021-210 Flexible Stainless Ruler, Graduated in 1/32" (0.8 mm) fractions and mm, 1/2" x 6" (1.3 x 15.2 cm)
- 1021-212 Flexible Stainless Ruler, Graduated in 1/32" (0.8 mm) fractions and mm, 3/4" x 12" (1.9 cm x 30.5 cm)
- 110-200 COLLIN Tongue Sizing Forceps, Jaws 25 mm wide, 6 $\frac{3}{4}$ " (17.1 cm)



110-203



110-205



110-208



110-210

DIAGNOSTIC INSTRUMENTS

- 110-203 YOUNG Tongue Sizing Forceps, With soft rubber jaws, 6½" (16.5 cm)
- 110-205 YANKAUER Suction Tube, With removable tip, Stainless, 11¼" (29.8 cm)
- 110-208 Tip for YANKAUER Suction Tube
- 110-210 YANKAUER Pediatric Suction Tube, With removable tip, Delicate pattern, 8½" (21.6 cm)



110-213

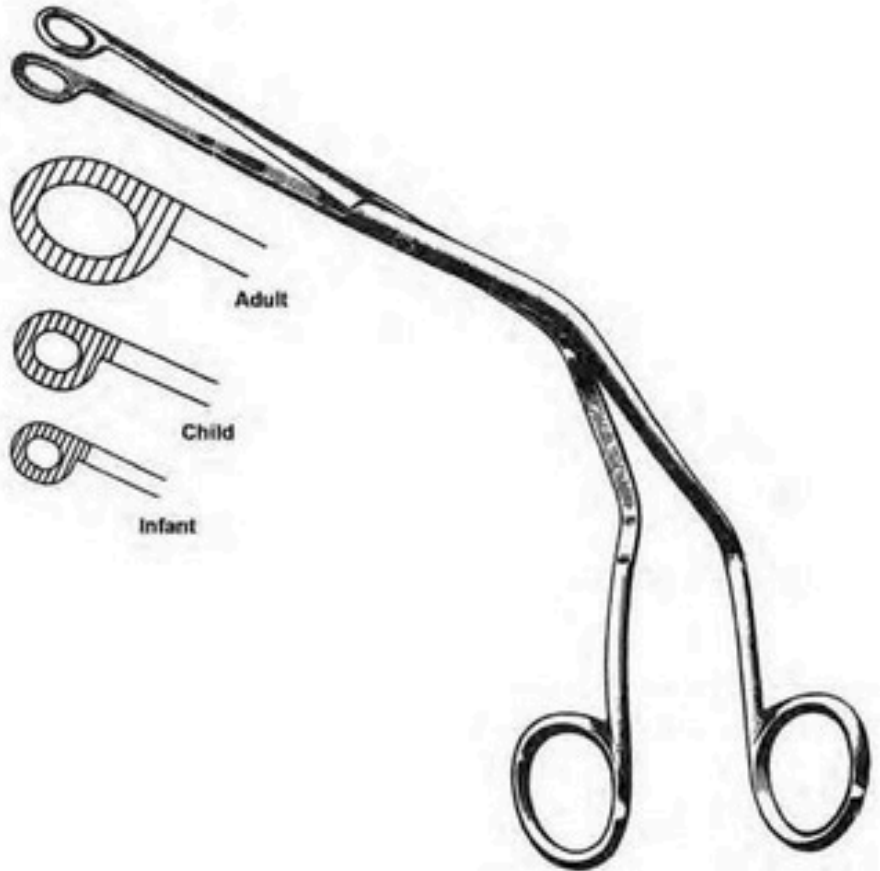

110-270
110-275
110-280



169-479

DIAGNOSTIC INSTRUMENTS

- 110-213 ANDREWS-PYNCHON Suction Tube, Delicate pattern, 8½" (21.6 cm)
- 169-479 BUIE Suction Tube, With Finger Valve, 15 Fr. (5 mm), 16" (40.6 cm)
- 110-270 MAGILL Endotracheal Catheter Introducing Forceps, Infant, 7" (17.8 cm)
- 110-275 MAGILL Endotracheal Catheter Introducing Forceps, Child, 8½" (21.6 cm)
- 110-280 MAGILL Endotracheal Catheter Introducing Forceps, Adult, 9¾" (24.8 cm)

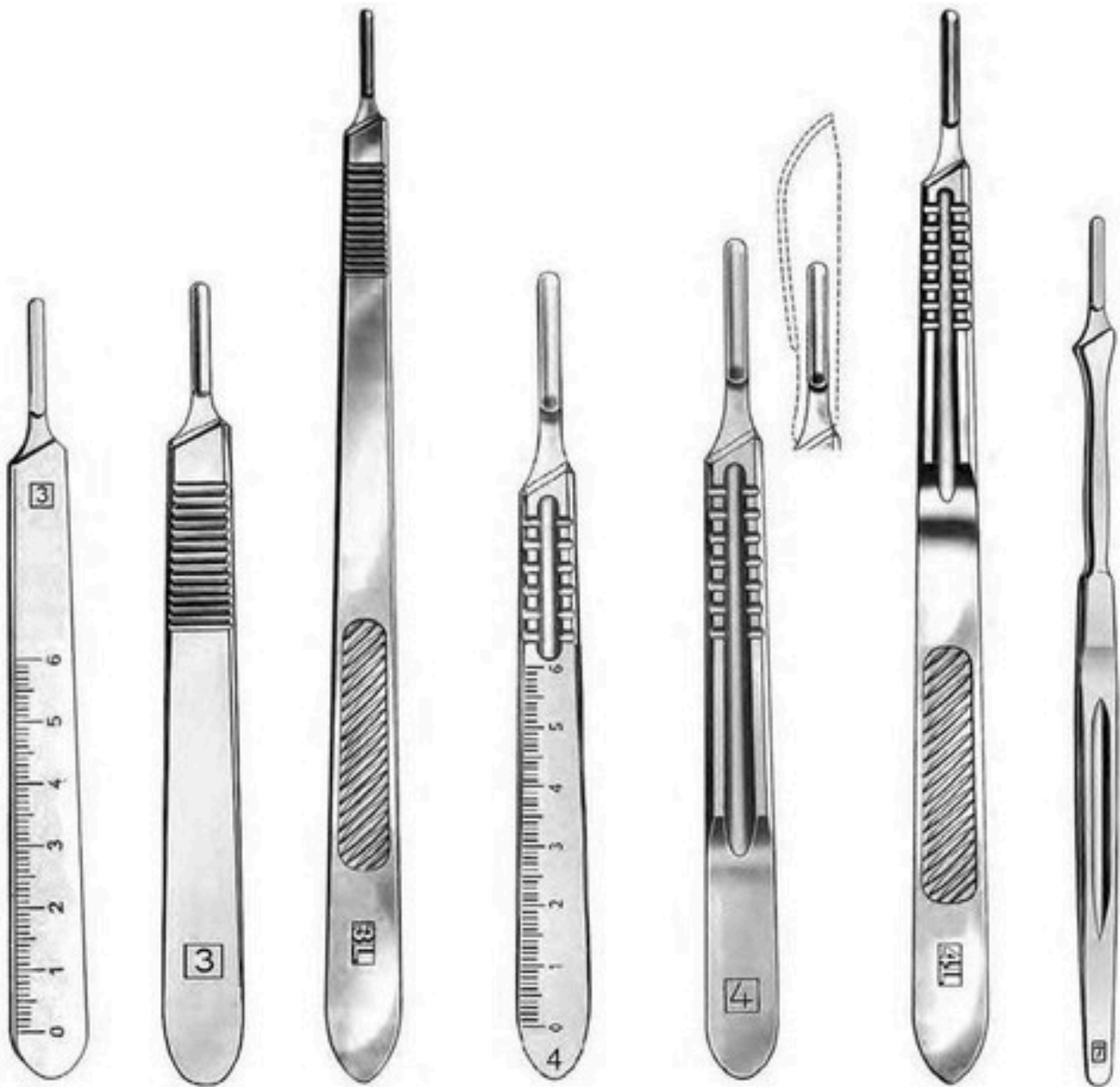

110-3001 10-305

110-3061 10-3081 10-310

110-311

110-315

SCALPEL HANDLES

- 110-300** Knife Handle No. 3, With Scale, fitting surgical blades Nos. 10 thru 15.
- 110-305** Knife Handle No. 3, Standard, fitting surgical blades Nos.10 thru 15.
- 110-306** Knife Handle No. 3L, Standard, fitting surgical blades Nos.10 thru 15
- 110-308** Knife Handle No. 4, With Scale, fitting surgical blades Nos. 20 thru 25
- 110-310** Knife Handle No. 4, Standard, fitting surgical blades Nos. 20 thru 25
- 110-311** Knife Handle No. 4L, Standard, fitting surgical blades Nos. 20 thru 25
- 110-315** Knife Handle No. 7, Fitting surgical blades Nos. 10 thru 15



110-305-F

110-310-F1 10-315-F

110-319-M

110-322-M

110-324-M

SCALPEL HANDLES

- 110-305-F** Feather Surgical Blade Handle No. 3 Fits Blades Nos. 10, 11, 12 and 15
- 110-310-F** Feather Surgical Blade Handle No. 4 Fits Blades Nos. 20, 21, 22 and 24
- 110-315-F** Feather Surgical Blade Handle No. 7 Fits Blades Nos. 10, 11, 12 and 15
- 110-319-M** Blade Handle No. 8, Plastic Handle, Fits Blades Nos. 60/70 (AJ115)
- 110-322-M** Stainless Steel Blade Handle, Smooth, Fits Blades Nos. 60/70 (AJ113)
- 110-324-M** Stainless Steel Blade Handle, Fluted, Fits Blades Nos. 60/70 (AJ114)

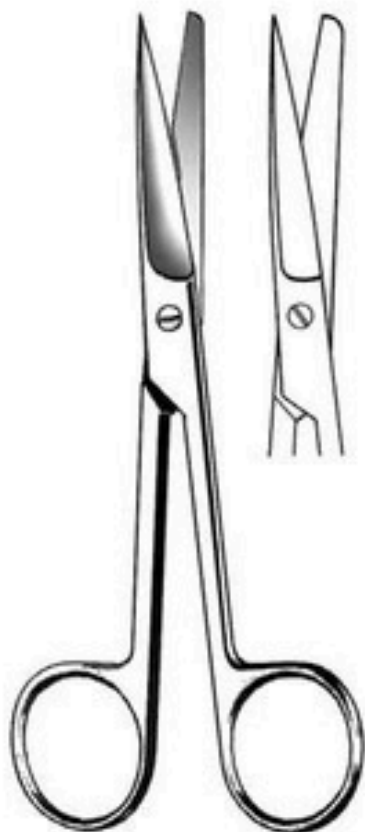

110-453
110-500
110-550
110-600

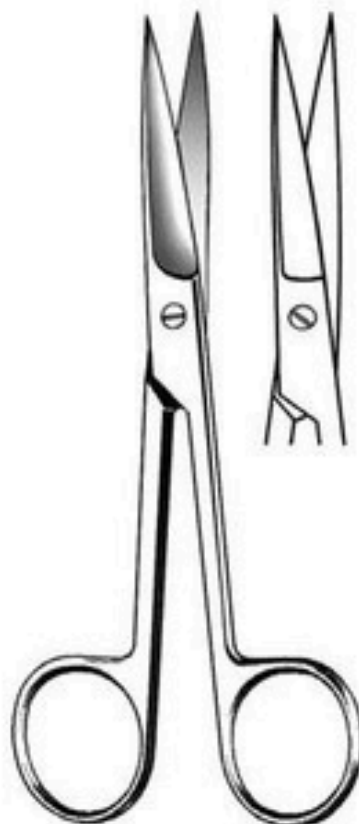

110-456
110-504
110-552
110-602

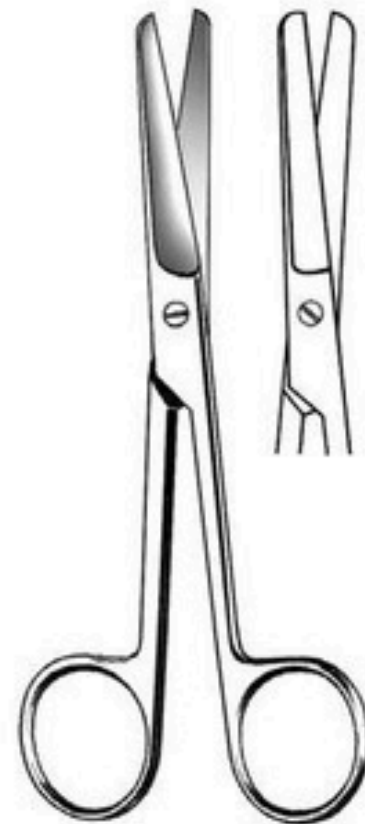

110-459
110-509
110-558
110-608

OPERATING SCISSORS

- | | |
|---------|---|
| 110-453 | Operating Scissors, Straight, Sharp/Blunt Points, 4½" (11.4 cm) |
| 110-456 | Operating Scissors, Straight, Sharp/Sharp Points, 4½" (11.4 cm) |
| 110-459 | Operating Scissors, Straight, Blunt/Blunt Points, 4½" (11.4 cm) |
| 110-500 | Operating Scissors, Straight, Sharp/Blunt Points, 5" (12.7 cm) |
| 110-504 | Operating Scissors, Straight, Sharp/Sharp Points, 5" (12.7 cm) |
| 110-509 | Operating Scissors, Straight, Blunt/Blunt Points, 5" (12.7 cm) |
| 110-550 | Operating Scissors, Straight, Sharp/Blunt Points, 5½" (14 cm) |
| 110-552 | Operating Scissors, Straight, Sharp/Sharp Points, 5½" (14 cm) |
| 110-558 | Operating Scissors, Straight, Blunt/Blunt Points, 5½" (14 cm) |
| 110-600 | Operating Scissors, Straight, Sharp/Blunt Points, 6½" (16.5 cm) |
| 110-602 | Operating Scissors, Straight, Sharp/Sharp Points, 6½" (16.5 cm) |
| 110-608 | Operating Scissors, Straight, Blunt/Blunt Points, 6½" (16.5 cm) |

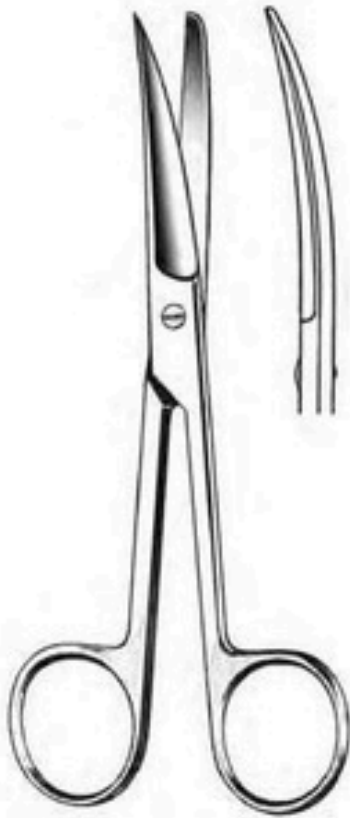

110-461
110-501
110-560
110-610

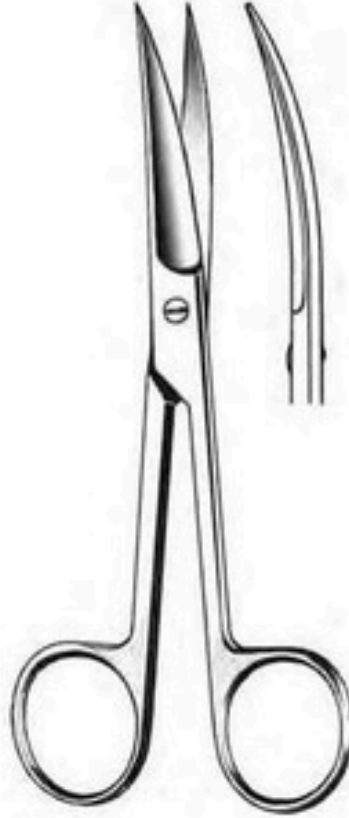

110-467
110-505
110-566
110-616

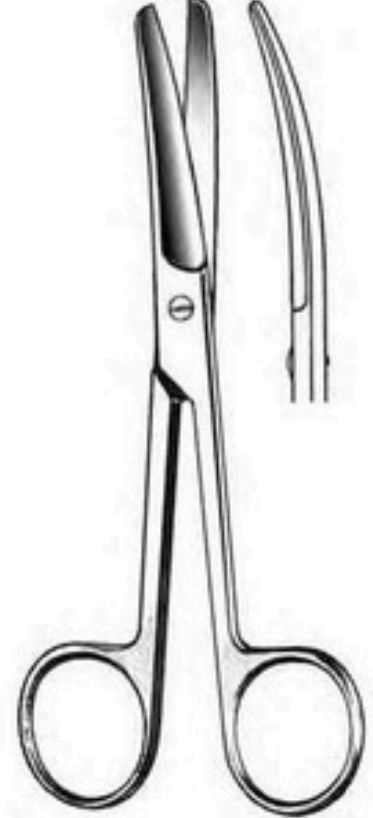

110-469
110-517
110-568
110-618

OPERATING SCISSORS

- | | |
|---------|---|
| 110-461 | Operating Scissors, Curved, Sharp/Blunt Points, 4½" (11.4 cm) |
| 110-467 | Operating Scissors, Curved, Sharp/Sharp Points, 4½" (11.4 cm) |
| 110-469 | Operating Scissors, Curved, Blunt/Blunt Points, 4½" (11.4 cm) |
| 110-501 | Operating Scissors, Curved, Sharp/Blunt Points, 5" (12.7 cm) |
| 110-505 | Operating Scissors, Curved, Sharp/Sharp Points, 5" (12.7 cm) |
| 110-517 | Operating Scissors, Curved, Blunt/Blunt Points, 5" (12.7 cm) |
| 110-560 | Operating Scissors, Curved, Sharp/Blunt Points, 5½" (14 cm) |
| 110-566 | Operating Scissors, Curved, Sharp/Sharp Points, 5½" (14 cm) |
| 110-568 | Operating Scissors, Curved, Blunt/Blunt Points, 5½" (14 cm) |
| 110-610 | Operating Scissors, Curved, Sharp/Blunt Points, 6½" (16.5 cm) |
| 110-616 | Operating Scissors, Curved, Sharp/Sharp Points, 6½" (16.5 cm) |
| 110-618 | Operating Scissors, Curved, Blunt/Blunt Points, 6½" (16.5 cm) |

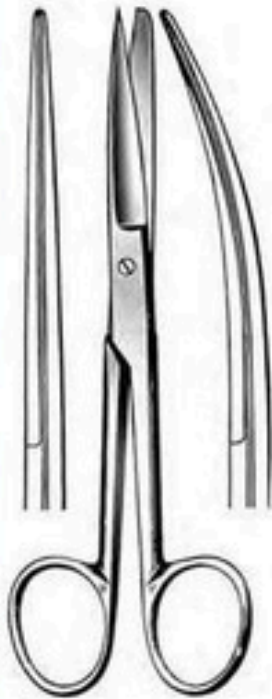

110-630
110-638

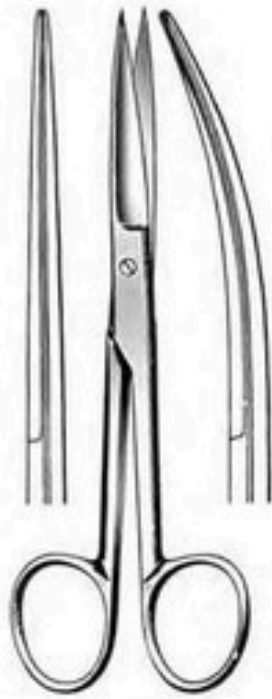

110-632
110-640



113-001
113-052



113-002
113-010

OPERATING SCISSORS

- | | |
|----------------|--|
| 110-630 | DEAVER Scissors, Straight, Sharp/Blunt Points, 5½" (14 cm) |
| 110-638 | DEAVER Scissors, Curved, Sharp/Blunt Points, 5½" (14 cm) |
| 110-632 | DEAVER Scissors, Straight, Sharp/Sharp Points, 5½" (14 cm) |
| 110-640 | DEAVER Scissors, Curved, Sharp/Sharp Points, 5½" (14cm) |
| 113-001 | IRIS Scissors, Straight, Sharp/Sharp Points, 3½" (8.9 cm) |
| 113-052 | IRIS Scissors, Curved, Sharp/Sharp Points, 3½" (8.9 cm) |
| 113-002 | IRIS Scissors, Straight, Sharp/Sharp Points, 4½" (11.4 cm) |
| 113-010 | IRIS Scissors, Curved, Sharp/Sharp Points, 4½" (11.4 cm) |



113-003
113-059



113-051
113-069

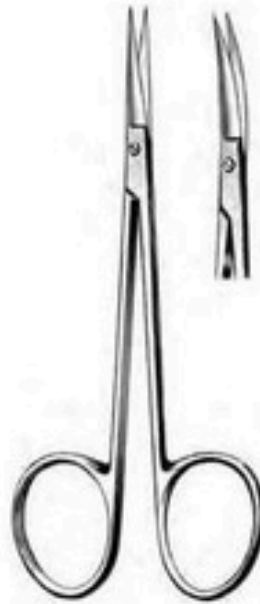

113-074
113-076



113-260
113-262
113-264

OPERATING SCISSORS

- | | |
|---------|---|
| 113-003 | IRIS Scissors, Straight, Sharp/Sharp Points, Delicate, 4" (10.2 cm) |
| 113-059 | IRIS Scissors, Curved, Sharp/Sharp Points, Delicate, 4" (10.2 cm) |
| 113-051 | IRIS Scissors, Straight, Sharp/Sharp Points, Delicate, 4 1/4" (10.8 cm) |
| 113-069 | IRIS Scissors, Curved, Sharp/Sharp Points, Delicate, 4 1/4" (10.8 cm) |
| 113-074 | IRIS Scissors, Straight, Sharp/Sharp Points, 4" (10.2 cm) |
| 113-076 | IRIS Scissors, Curved, Sharp/Sharp Points, 4" (10.2 cm) |
| 113-260 | Enucleation Scissors, Light Curve, 5" (12.7 cm) |
| 113-262 | Enucleation Scissors, Medium Curve, 5" (12.7 cm) |
| 113-264 | Enucleation Scissors, Full Curve, 5" (12.7 cm) |



113-520
113-522

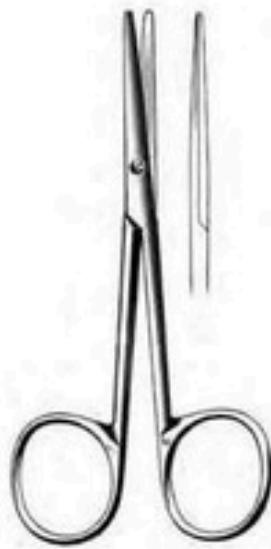

113-524



113-526

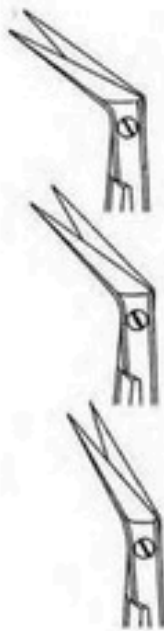

113-530
113-532
113-534

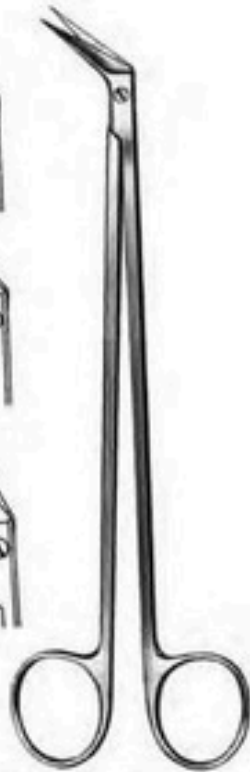

113-550

OPERATING SCISSORS

- 113-520 STEVENS Tenotomy Scissors, Straight, Blunt Points, 4½" (11.4 cm)
- 113-522 STEVENS Tenotomy Scissors, Curved, Blunt Points, 4½" (11.4 cm)
- 113-524 Strabismus Scissors, Straight, 4½" (11.4 cm)
- 113-526 Strabismus Scissors, Curved, 4½" (11.4 cm)
- 113-530 POTTS-SMITH Scissors, Angled on Side 25°, 7½" (19.1 cm)
- 113-532 POTTS-SMITH Scissors, Angled on Side 45°, 7½" (19.1 cm)
- 113-534 POTTS-SMITH Scissors, Angled on Side 60°, 7½" (19.1 cm)
- 113-550 Enterotomy Scissors With Hook Blade, 8" (20.3 cm)



113-552

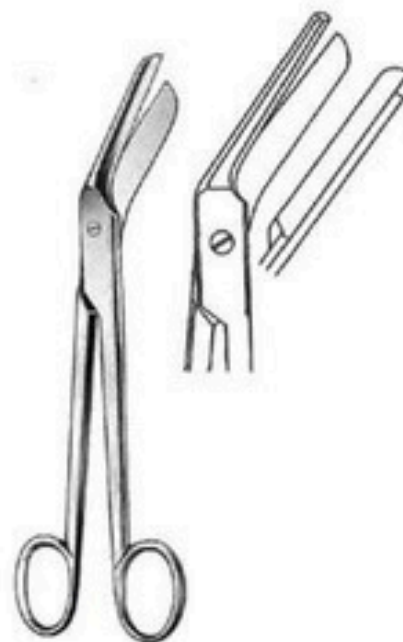

113-560

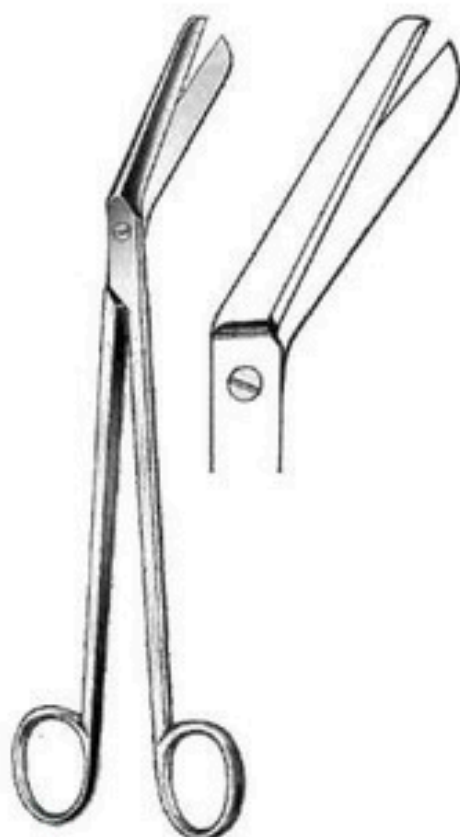

113-562



113-565

OPERATING SCISSORS

- 113-552 Umbilical Scissors, American Pattern, 4 1/2" (10.5 cm)
- 113-560 BRAUN Episiotomy Scissors, Guarded Lower Blade, Angled to Side, 5 1/2" (14 cm)
- 113-562 BRAUN Episiotomy Scissors, Guarded Lower Blade, Angled to Side, 8 1/2" (21.6 cm)
- 113-565 FERGUSON Abdominal Scissors, Angled on flat, 7" (17.8 cm)

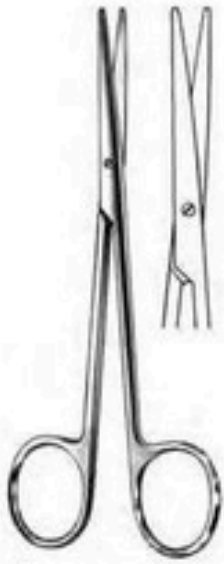

115-445



115-448



115-550



115-552



115-555



115-556

OPERATING SCISSORS

- | | |
|---------|--|
| 115-445 | Baby METZENBAUM Scissors, Straight, 5" (12.7 cm) |
| 115-448 | Baby METZENBAUM Scissors, Curved, 5" (12.7 cm) |
| 115-550 | METZENBAUM Scissors, Straight, 5½" (14 cm) |
| 115-552 | METZENBAUM Scissors, Curved, 5½" (14 cm) |
| 115-555 | METZENBAUM Scissors, Straight, 7" (17.8 cm) |
| 115-556 | METZENBAUM Scissors, Curved, 7" (17.8 cm) |



115-558



115-5611 15-5631 15-5651 15-567



115-559



115-5621 15-5641 15-5661 15-568

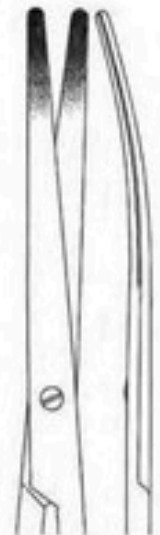

OPERATING SCISSORS

- 115-558 METZENBAUM Scissors, Straight, 8" (20.3 cm)
- 115-559 METZENBAUM Scissors, Curved, 8" (20.3 cm)
- 115-561 METZENBAUM-(NELSON) Scissors, Straight, 9" (22.9 cm)
- 115-562 METZENBAUM-(NELSON) Scissors, Curved, 9" (22.9 cm)
- 115-563 METZENBAUM-(NELSON) Scissors, Straight, 10" (25.4 cm)
- 115-564 METZENBAUM-(NELSON) Scissors, Curved, 10" (25.4 cm)
- 115-565 METZENBAUM-(NELSON) Scissors, Straight, 11" (27.9 cm)
- 115-566 METZENBAUM-(NELSON) Scissors, Curved, 11" (27.9 cm)
- 115-567 METZENBAUM-(NELSON) Scissors, Straight, 12" (30.5 cm)
- 115-568 METZENBAUM-(NELSON) Scissors, Curved, 12" (30.5 cm)

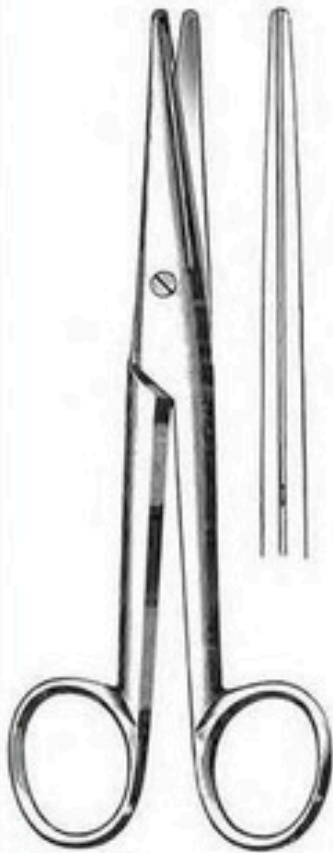

115-570

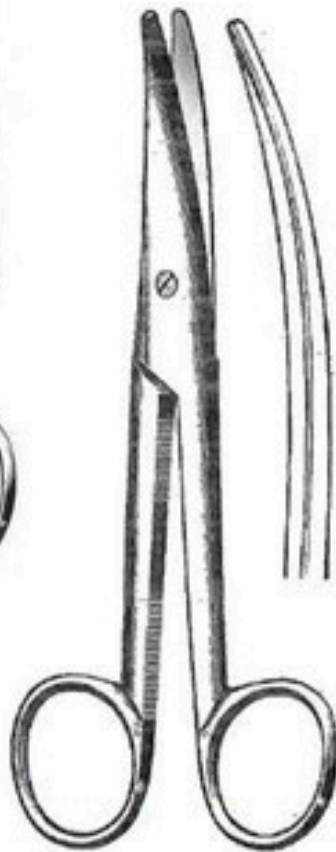

115-571



115-572

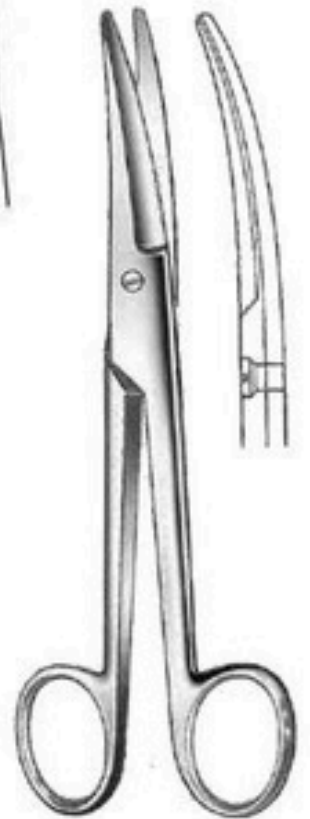

115-573

OPERATING SCISSORS

- 115-570 MAYO-NOBLE Dissecting Scissors, Straight, Rounded Blades, 6½" (16.5cm)
- 115-571 MAYO-NOBLE Dissecting Scissors, Curved, Rounded Blades, 6½" (16.5 cm)
- 115-572 MAYO-NOBLE Dissecting Scissors, Straight, Beveled Blades, 6½" (16.5 cm)
- 115-573 MAYO-NOBLE Dissecting Scissors, Curved, Beveled Blades, 6½" (16.5 cm)

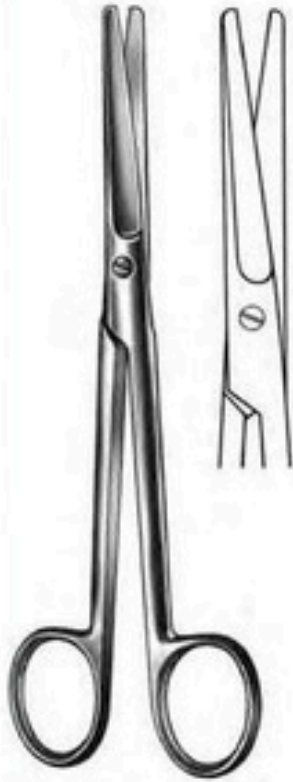

115-575
115-579

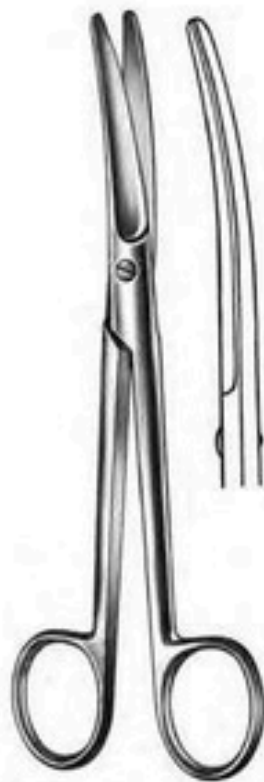

115-576
115-580

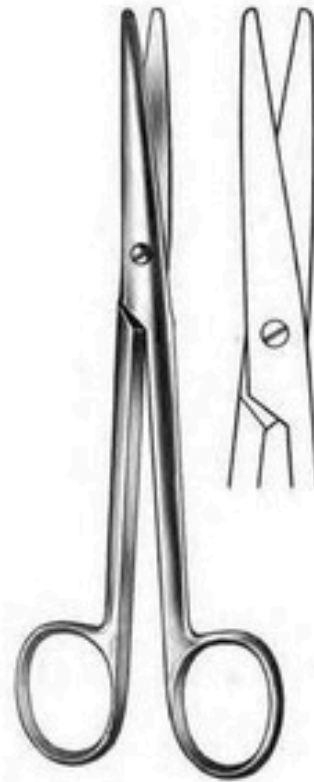

115-577
115-583

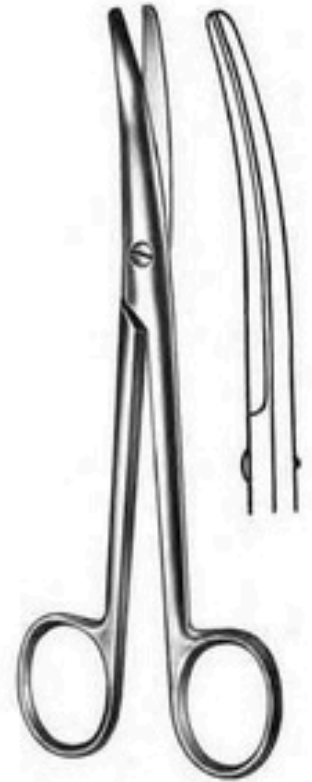

115-578
115-584

OPERATING SCISSORS

- | | |
|---------|--|
| 115-575 | MAYO Dissecting Scissors, Straight, 5½" (14 cm) |
| 115-576 | MAYO Dissecting Scissors, Curved, 5½" (14 cm) |
| 115-579 | MAYO Dissecting Scissors, Straight, 6¾" (17.1 cm) |
| 115-580 | MAYO Dissecting Scissors, Curved, 6¾" (17.1 cm) |
| 115-577 | MAYO-STILLE Dissecting Scissors, Straight, Rounded Blades, 5½" (14 cm) |
| 115-578 | MAYO-STILLE Dissecting Scissors, Curved, Rounded Blades, 5½" (14 cm) |
| 115-583 | MAYO-STILLE Dissecting Scissors, Straight, Rounded Blades, 6¾" (17.1 cm) |
| 115-584 | MAYO-STILLE Dissecting Scissors, Curved, Rounded Blades, 6¾" (17.1 cm) |



115-585-A
115-585-B



115-586-A
115-586-B

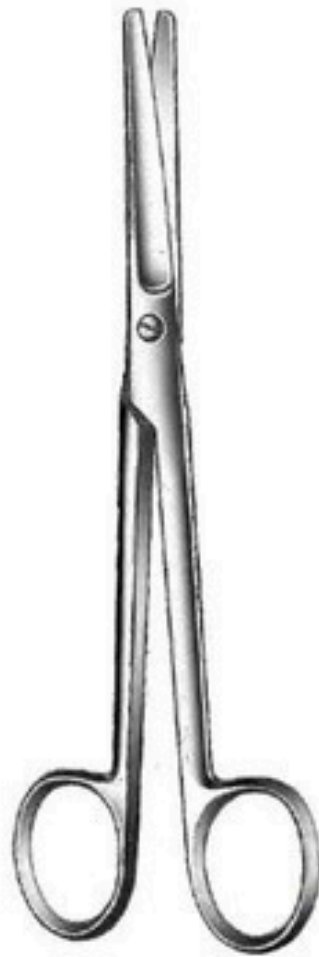

115-585
115-587-A



115-586
115-587-B

OPERATING SCISSORS

- 115-585-A MAYO-HARRINGTON Dissecting Scissors, Straight, 9" (22.9 cm)
- 115-586-A MAYO-HARRINGTON Dissecting Scissors, Curved, 9" (22.9 cm)
- 115-585-B MAYO-HARRINGTON Dissecting Scissors, Straight, 11" (27.9 cm)
- 115-586-B MAYO-HARRINGTON Dissecting Scissors, Curved, 11" (27.9 cm)

- 115-585 MAYO Dissecting Scissors, Straight, 9" (22.9 cm)
- 115-586 MAYO Dissecting Scissors, Curved, 9" (22.9 cm)

- 115-587-A MAYO Dissecting Scissors, Straight, 12" (30.5 cm)
- 115-587-B MAYO Dissecting Scissors, Curved, 12" (30.5 cm)



115-588



115-590



115-591



115-593



115-594



115-597



115-598

OPERATING SCISSORS

- 115-588 NOYES IRIS Scissors, Sharp/Sharp Points, Straight, 4½" (11.4 cm)
- 115-590 NOYES IRIS Scissors, Sharp/Sharp Points, Curved, 4½" (11.4 cm)
- 115-591 NOYES IRIS Scissors, Sharp/Sharp Points, Angled, 4½" (11.4 cm)
- 115-593 CASTROVIEJO Scissors, Sharp/Sharp Points, Straight, 4¼" (10.8 cm)
- 115-594 CASTROVIEJO Scissors, Sharp/Sharp Points, Curved, 4¼" (10.8 cm)
- 115-597 WESTCOTT Stitch Scissors, Sharp Points, Curved, 4½" (11.4 cm)
- 115-598 WESTCOTT Stitch Scissors, Blunt Points, Curved, 4½" (11.4 cm)



SYSTEMS
of quality

***SURGICAL SCISSORS WITH TC-INSERTS
TUN ITEN CARBIDE***

GENERAL SURGICAL

*Tun Iten Carbide Inserts
Seamlessly bonded and
finished*

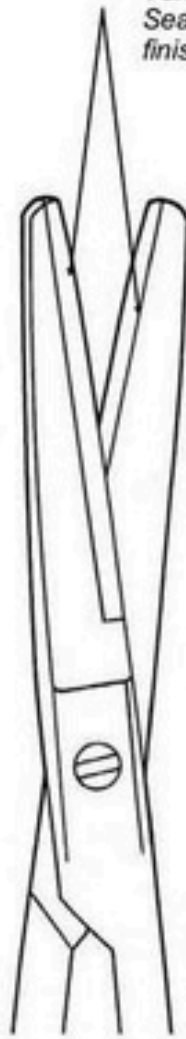



116-800
116-805
116-815

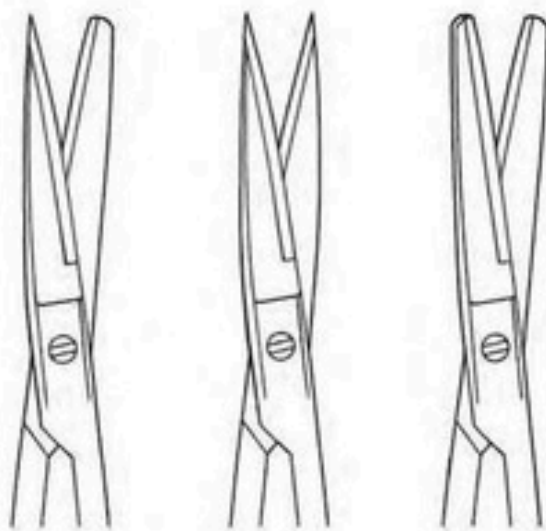

116-802
116-807
116-818

OPERATING SCISSORS TUN 1TEN CARBIDE

- 116-800 Operating Scissors, Straight, Sharp/Sharp Points, T.C. blades, 5½" (14 cm)
- 116-802 Operating Scissors, Curved, Sharp/Sharp Points, T.C. blades, 5½" (14 cm)
- 116-805 Operating Scissors, Straight, Sharp/Blunt Points, T.C. blades, 5½" (14 cm)
- 116-807 Operating Scissors, Curved, Sharp/Blunt Points, T.C. blades, 5½" (14 cm)
- 116-815 Operating Scissors, Straight, Blunt/Blunt Points, T.C. blades, 5½" (14 cm)
- 116-818 Operating Scissors, Curved, Blunt/Blunt Points, T.C. blades, 5½" (14 cm)

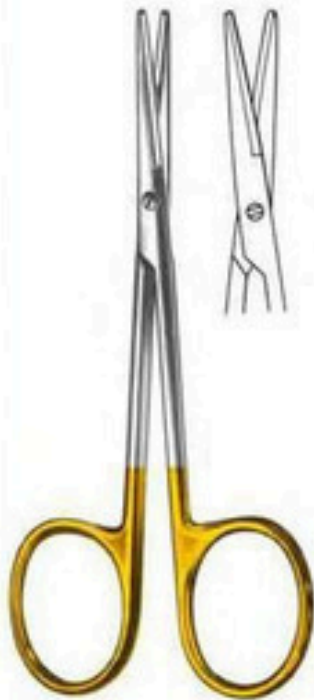

116-820



116-825



116-826



116-830

OPERATING SCISSORS TUN 1TEN CARBIDE

- 116-820 Strabismus Scissors, Straight, T.C. blades, 4½" (11.4 cm)
- 116-825 Strabismus Scissors, Curved, T.C. blades, 4½" (11.4 cm)
- 116-826 IRIS Scissors, Straight, T.C. blades, 4½" (11.4 cm)
- 116-830 IRIS Scissors, Curved, T.C. blades, 4½" (11.4 cm)

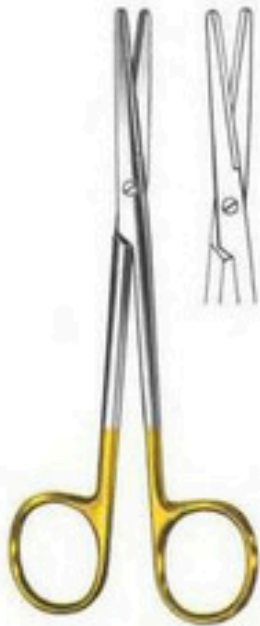

116-835



116-838

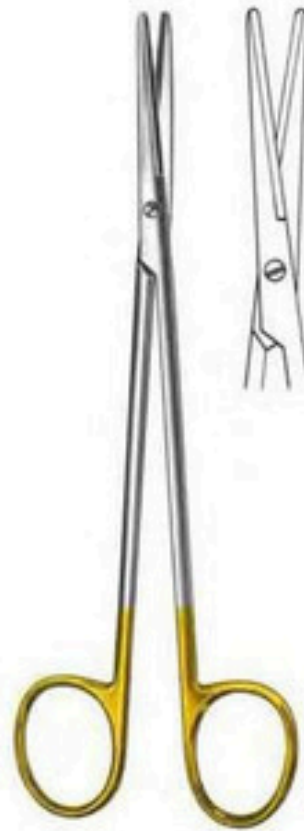

116-839
to
116-849



116-841
to
116-850

OPERATING SCISSORS TUN 1TEN CARBIDE

- | | |
|---------|---|
| 116-835 | METZENBAUM (Lahey) Scissors, Straight, T.C. blades, 5½" (14 cm) |
| 116-838 | METZENBAUM (Lahey) Scissors, Curved, T.C. blades, 5½" (14 cm) |
| 116-839 | METZENBAUM Scissors, Straight, T.C. blades, 7" (17.8 cm) |
| 116-841 | METZENBAUM Scissors, Curved, T.C. blades, 7" (17.8 cm) |
| 116-843 | METZENBAUM Scissors, Straight, T.C. blades, 9" (22.9 cm) |
| 116-844 | METZENBAUM Scissors, Curved, T.C. blades, 9" (22.9 cm) |
| 116-845 | METZENBAUM Scissors, Straight, T.C. blades, 10" (25.4 cm) |
| 116-846 | METZENBAUM Scissors, Curved, T.C. blades, 10" (25.4 cm) |
| 116-847 | METZENBAUM Scissors, Straight, T.C. blades, 11" (27.9 cm) |
| 116-848 | METZENBAUM Scissors, Curved, T.C. blades, 11" (27.9 cm) |
| 116-849 | METZENBAUM Scissors, Straight, T.C. blades, 12" (30.5 cm) |
| 116-850 | METZENBAUM Scissors, Curved, T.C. blades, 12" (30.5 cm) |

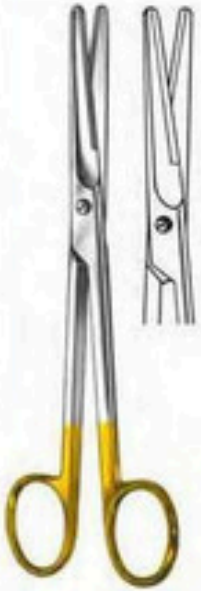

116-851
116-854

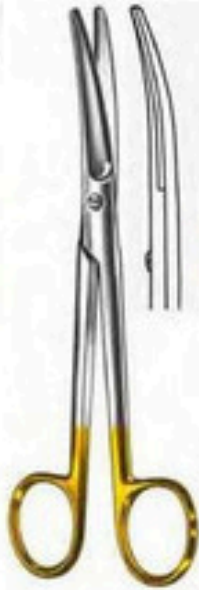

116-852
116-856

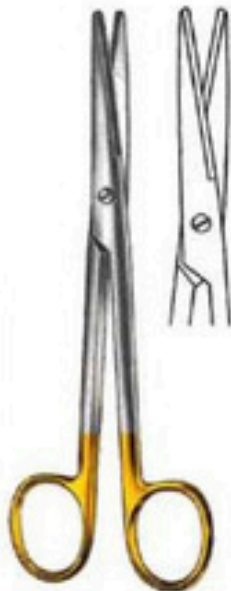

116-853
116-857



116-855
116-859



116-858



116-860

OPERATING SCISSORS TUN 1TEN CARBIDE

- 116-851 MAYO Dissecting Scissors, Straight, T.C. blades, 5½" (14 cm)
- 116-852 MAYO Dissecting Scissors, Curved, T.C. blades, 5½" (14 cm)
- 116-854 MAYO Dissecting Scissors, Straight, T.C. blades, 6¾" (17.1 cm)
- 116-856 MAYO Dissecting Scissors, Curved, T.C. blades, 6¾" (17.1 cm)
- 116-853 MAYO Dissecting Scissors, Straight, T.C. blades, 5½" (14 cm), Rounded Blades
- 116-855 MAYO Dissecting Scissors, Curved, T.C. blades, 5½" (14 cm), Rounded Blades
- 116-857 MAYO Dissecting Scissors, Straight, T.C. blades, 6¾" (17.1 cm), Rounded Blades
- 116-859 MAYO Dissecting Scissors, Curved, T.C. blades, 6¾" (17.1 cm), Rounded Blades
- 116-858 MAYO Dissecting Scissors, Straight, T.C. blades, 9" (22.9 cm)
- 116-860 MAYO Dissecting Scissors, Curved, T.C. blades, 9" (22.9 cm)



116-865



116-866



116-870

OPERATING SCISSORS TUN 1TEN CARBIDE

- 116-865 GOLDMAN-FOX Scissors, Serrated Blade, Straight, T.C. blades, 5" (12.7 cm)
- 116-866 GOLDMAN-FOX Scissors, Serrated Blade, Curved, T.C. blades, 5" (12.7 cm)
- 116-870 ROGER Wire Scissors, Angular, One Blade Serrated, T.C. blades, 4¼" (12.1 cm)



SYSTEMS
of quality

GENERAL SURGICAL

SUPER-CUT SCISSORS

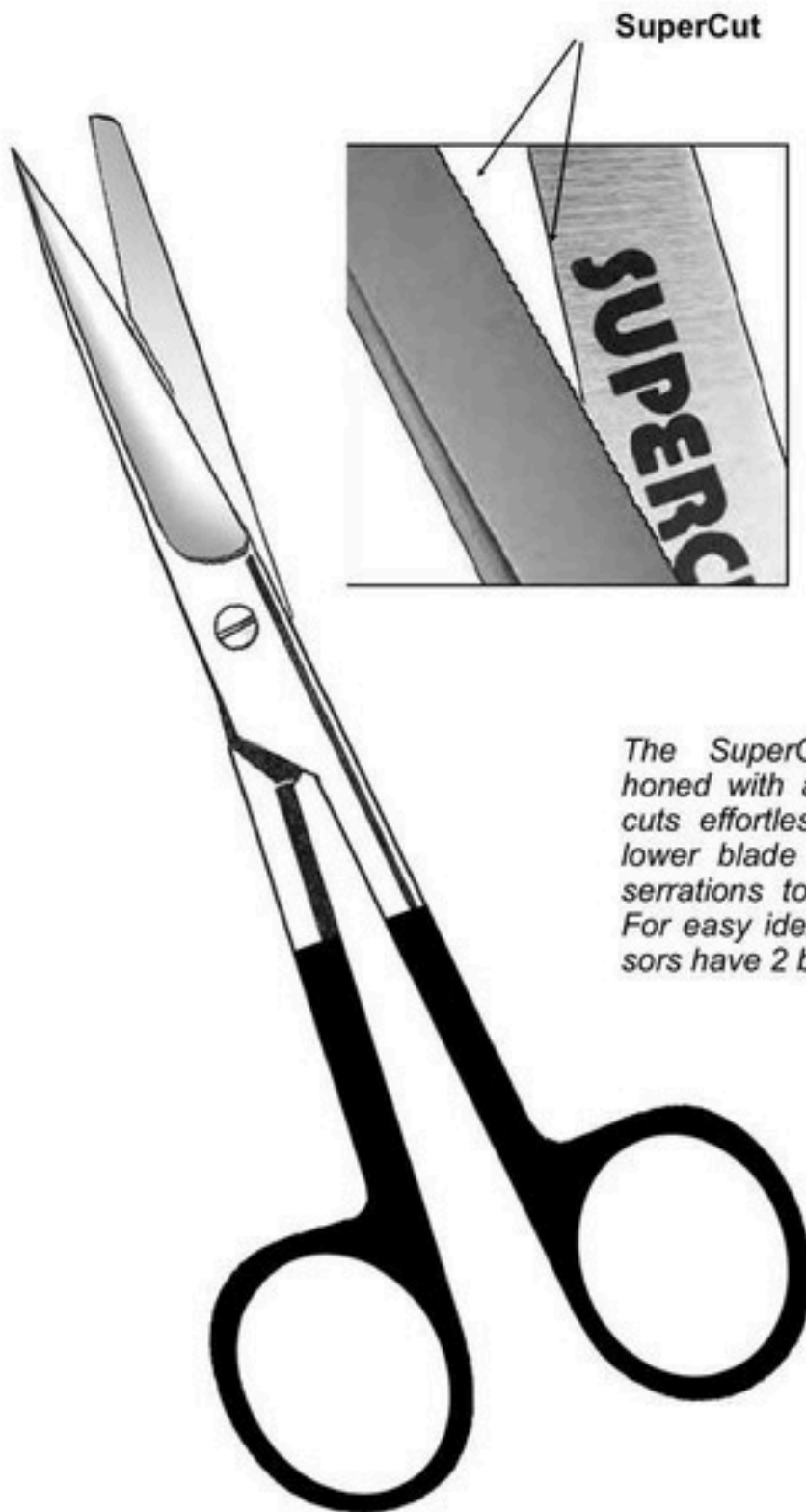

The SuperCut Scissors blade are honed with a Razor Sharp Edge that cuts effortlessly through tissue. The lower blade is beveled and has fine serrations to prevent tissue slippage. For easy identification, SuperCut Scissors have 2 black plated finger rings.

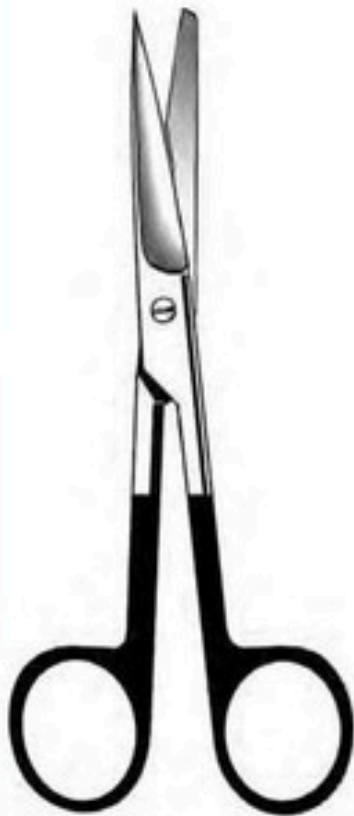

117-200
117-204

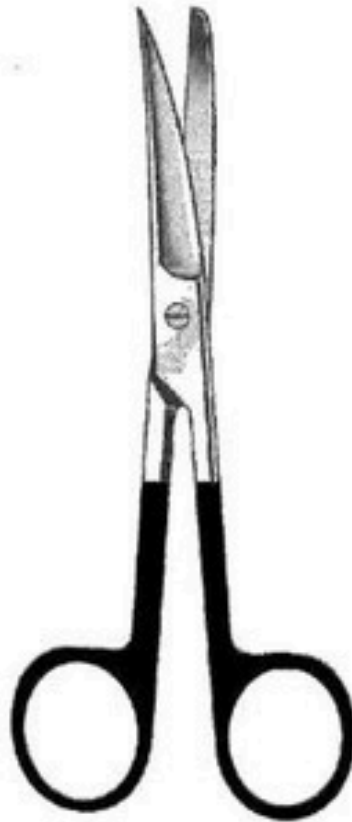

117-202
117-206



117-208



117-210

SUPER-CUT SCISSORS

- | | |
|---------|---|
| 117-200 | Super-Cut Operating Scissors, Straight, Sharp/Blunt, 5" (12.7 cm) |
| 117-202 | Super-Cut Operating Scissors, Curved, Sharp/Blunt, 5" (12.7 cm) |
| 117-204 | Super-Cut Operating Scissors, Straight, Sharp/Blunt, 5½" (14 cm) |
| 117-206 | Super-Cut Operating Scissors, Curved, Sharp/Blunt, 5½" (14 cm) |
| 117-208 | Super-Cut IRIS Scissors, Straight, 4½" (11.4 cm) |
| 117-210 | Super-Cut IRIS Scissors, Curved, 4½" (11.4 cm) |

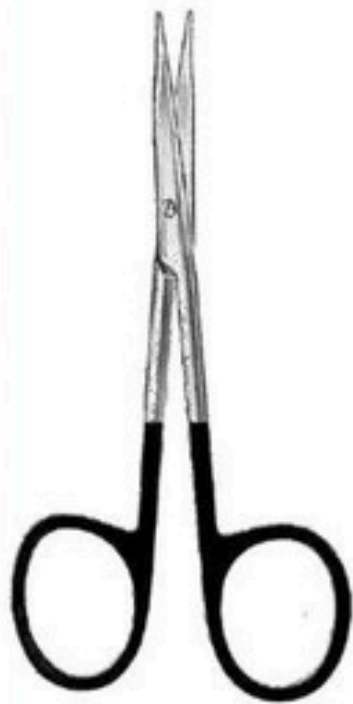

117-212



117-214



117-216

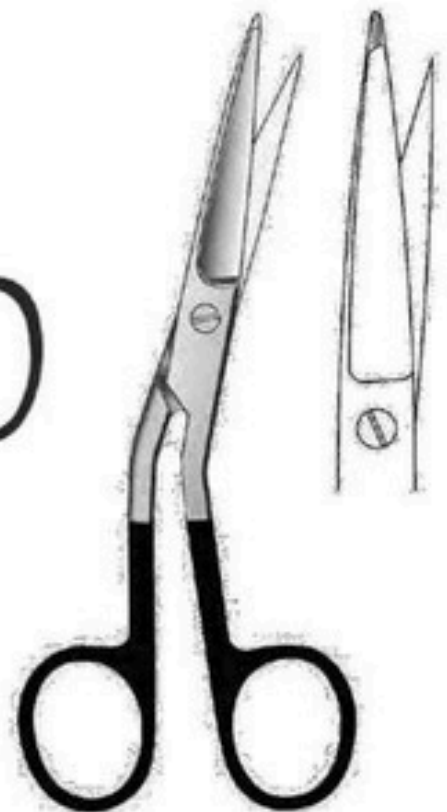

117-217

SUPER-CUT SCISSORS

- 117-212 Super-Cut STEVENS Tenotomy Scissors, Straight, 4½" (11.4 cm)
- 117-214 Super-Cut STEVENS Tenotomy Scissors, Curved, 4½" (11.4 cm)
- 117-216 Super-Cut GRADLE Suture Scissors, Slightly Curved, 3¾" (9.5 cm)
- 117-217 Super-Cut KNOWLES Bandage Scissors, Offset Shanks with fine knob, 5" (12.7 cm)

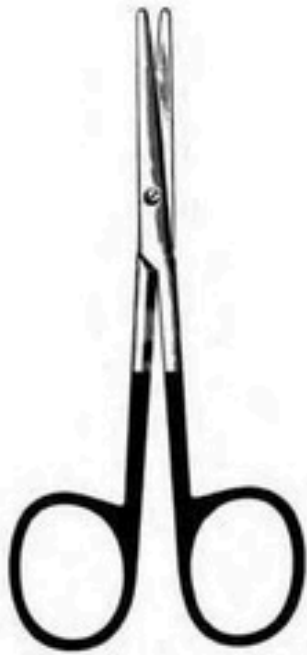

117-218



117-220



117-222



117-252



117-254

SUPER-CUT SCISSORS

- 117-218 Super-Cut Strabismus (METZENTBAUM) Scissors, Straight, blunt, 4½" (11.4 cm)
- 117-220 Super-Cut Strabismus (METZENBAUM) Scissors, Curved, blunt, 4½" (11.4 cm)
- 117-222 Super-Cut GOLDMAN-FOX Scissors, Curved, 5" (12.7 cm)
- 117-252 Super-Cut IRIS Scissors, Straight, T.C. Blades, 4½" (11.4 cm)
- 117-254 Super-Cut IRIS Scissors, Curved, T.C. Blades, 4½" (11.4 cm)



117-224



117-226



117-228



117-230

SUPER-CUT SCISSORS

- | | |
|---------|---|
| 117-224 | Super-Cut METZENBAUM Scissors, Straight, 5½" (14 cm) |
| 117-226 | Super-Cut METZENBAUM Scissors, Curved, 5½" (14 cm) |
| 117-228 | Super-Cut METZENBAUM Scissors, Straight, 7" (17.8 cm) |
| 117-230 | Super-Cut METZENBAUM Scissors, Curved, 7" (17.8 cm) |



117-256

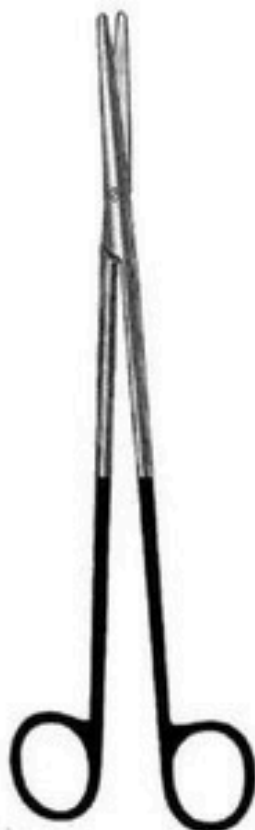

117-232
117-236



117-234
117-238

SUPER-CUT SCISSORS

- | | |
|---------|--|
| 117-256 | Super-Cut METZENBAUM Scissors, Curved, T.C. blades, 7" (17.8 cm) |
| 117-232 | Super-Cut METZENBAUM Scissors, Straight, 8" (20.3 cm) |
| 117-234 | Super-Cut METZENBAUM Scissors, Curved, 8" (20.3 cm) |
| 117-236 | Super-Cut METZENBAUM Scissors, Straight, 9" (22.9 cm) |
| 117-238 | Super-Cut METZENBAUM Scissors, Curved, 9" (22.9 cm) |



117-240
117-244



117-242
117-246



117-248

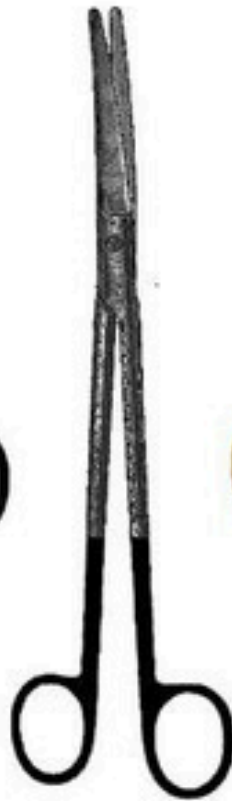

117-250



117-258



117-260

SUPER-CUT SCISSORS

- | | |
|---------|--|
| 117-240 | Super-Cut MAYO Scissors, Straight, 5½" (14 cm) |
| 117-242 | Super-Cut MAYO Scissors, Curved, 5½" (14 cm) |
| 117-244 | Super-Cut MAYO Scissors, Straight, 6¾" (17.1 cm) |
| 117-246 | Super-Cut MAYO Scissors, Curved, 6¾" (17.1 cm) |
| 117-248 | Super-Cut MAYO Scissors, Straight, 9" (22.9 cm) |
| 117-250 | Super-Cut MAYO Scissors, Curved, 9" (22.9 cm) |
| 117-258 | Super-Cut MAYO Scissors, Straight, T.C. Blades, 9" (22.9 cm) |
| 117-260 | Super-Cut MAYO Scissors, Curved, T.C. Blades, 9" (22.9 cm) |

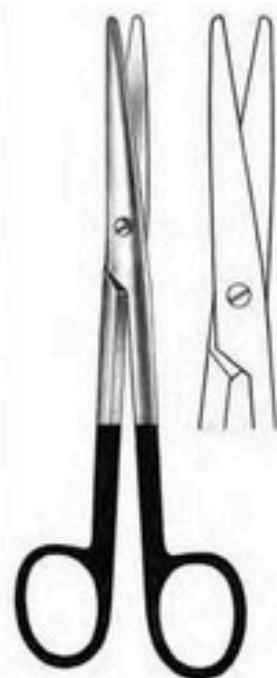

117-265
117-270

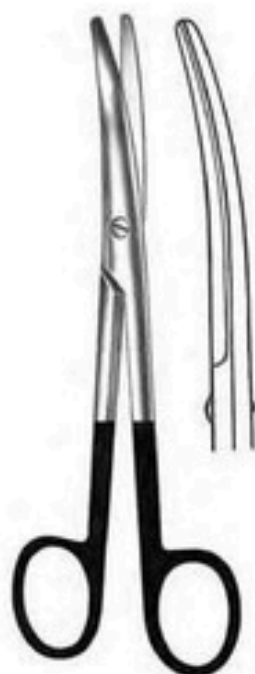

117-267
117-272



117-280



117-285

SUPER-CUT SCISSORS

- 117-265 Super-Cut MAYO-STILLE Scissors, Straight, Rounded Blades, 5½" (14 cm)
- 117-267 Super-Cut MAYO-STILLE Scissors, Curved, Rounded Blades, 5½" (14 cm)
- 117-270 Super-Cut MAYO-STILLE Scissors, Straight, Rounded Blades, 6¼" (17.1 cm)
- 117-272 Super-Cut MAYO-STILLE Scissors, Curved, Rounded Blades, 6¼" (17.1 cm)
- 117-280 Super-Cut COTTLE Dorsal Scissors, Heavy pattern, Rounded blades, Angular shanks, 6½" (16.5 cm)
- 117-285 Super-Cut FOMON Dorsal Scissors, Light pattern, Angular shanks, 5½" (14 cm)

EMT SHEARS



118-616



118-623

PLASTER CAST INSTRUMENTS EMT SHEARS AVAILABLE IN ASSORTED COLORS

- 118-616** EMT Bandage and Utility Scissors, needle destroyer, Serrated, autoclavable, 5½" (14 cm)
- 118-623** EMT Bandage and Utility Scissors, needle destroyer, Serrated, Autoclavable, 7½" (19.1 cm)



118-730



118-735



118-740
118-750



118-755
118-760

BANDAGE SCISSORS

- | | |
|---------|--|
| 118-730 | LISTER Bandage Scissors, 4½" (11.4 cm) |
| 118-735 | LISTER Bandage Scissors, 5½" (14 cm) |
| 118-740 | LISTER Bandage Scissors, 7¼" (18.4 cm) |
| 118-750 | LISTER Bandage Scissors, 8" (20.3 cm) |
| 118-755 | LISTER Bandage Scissors, One Large Ring, 7½" (19.1 cm) |
| 118-760 | LISTER Bandage Scissors, One Large Ring, 8" (20.3 cm) |



118-761



118-762



118-765



118-770

BANDAGE SCISSORS

- 118-761 BERGMAN Bandage and Plaster Shears, 9" (22.9 cm)
- 118-762 U.S.A. Gauze Scissors, 8" (20.3 cm)
- 118-765 RICHTER Dissecting Scissors, Angular, Sharp/Blunt Blades, 5" (12.7 cm)
- 118-770 KNOWLES Bandage Scissors, Straight, 5½" (14 cm)
- 118-775 HI-LEVEL (KNOWLES) Bandage Scissors, Shanks Angled on Side, Serrated Blade, 5½" (14 cm)



118-775



118-780

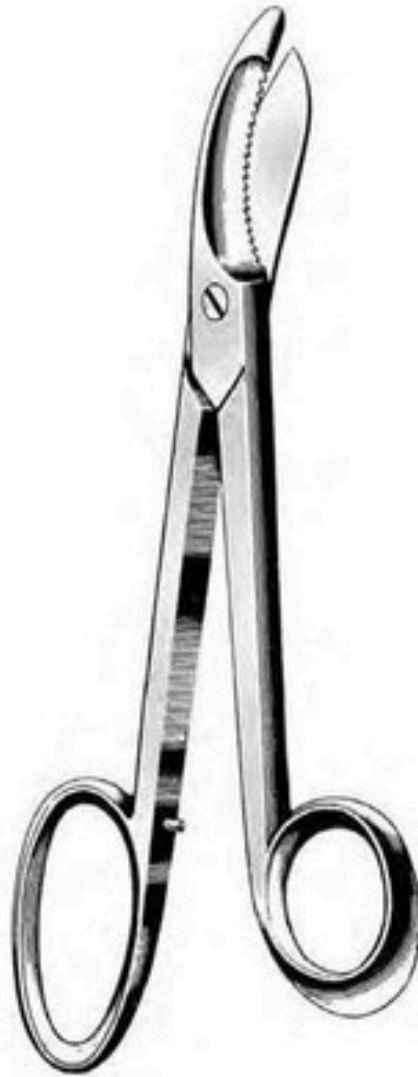

118-785

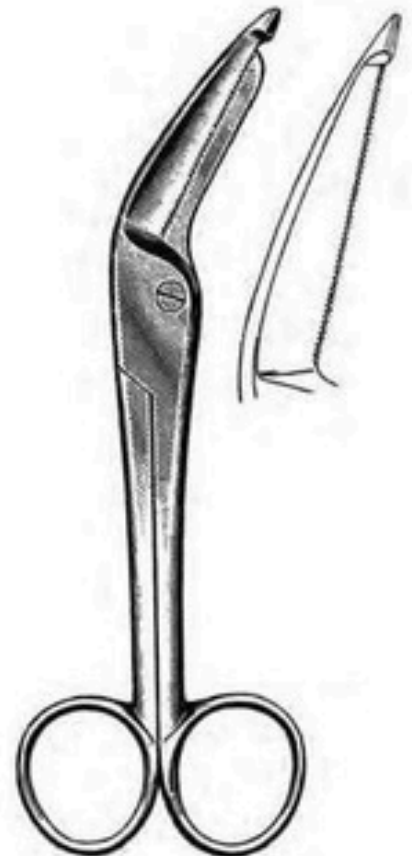

118-790

CAST SHEARS

- 118-780 ESMARCH Heavy Duty Bandage and Cast Shear, 8" (20.3 cm)
- 118-785 BRUNS Plaster Shears, Serrated Blade, 9¼" (23.5 cm)
- 118-790 HERCULES Heavy Duty Bandage Scissors, One Serrated Blade, 7½" (19.1 cm)

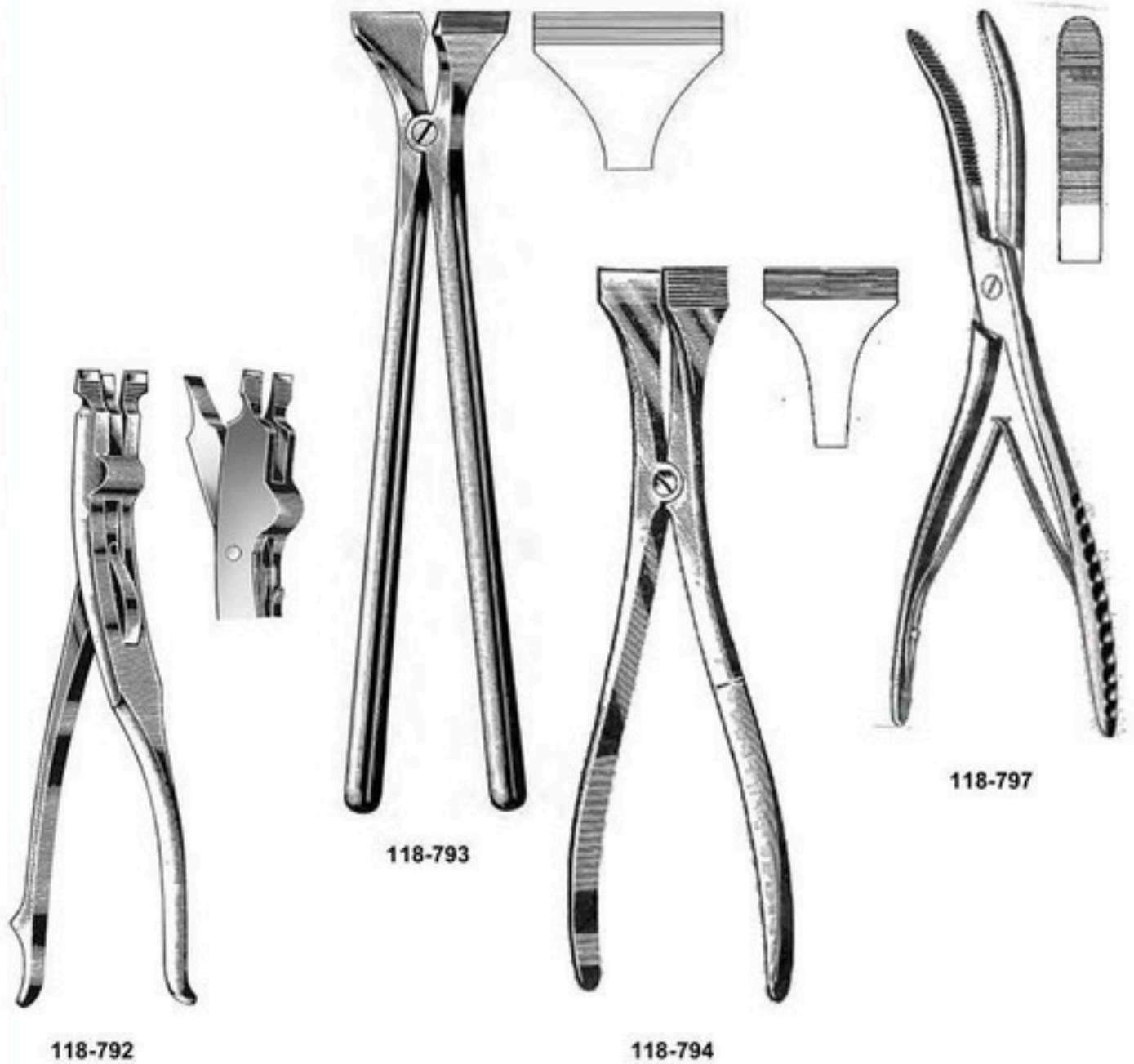

CAST INSTRUMENTS

- 118-792** FINE 3-Prong Cast Spreader, With Spring Action for One-Hand Operation, 9" (22.9 cm)
- 118-793** BEESON Cast Spreader, Blades 2" (5.1 cm) Wide, 12" (30.5 cm)
- 118-794** HENNIG Cast Spreader, Blades 2" (5.1 cm) Wide, 11" (27.9 cm)
- 118-797** WOLFE-BOEHLER Cast Breaker, Jaws 15 mm Wide With deep Serrations, 10" (25.4 cm)



119-445

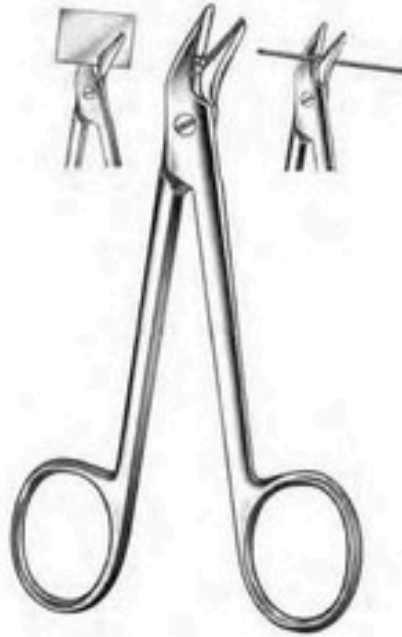

119-450

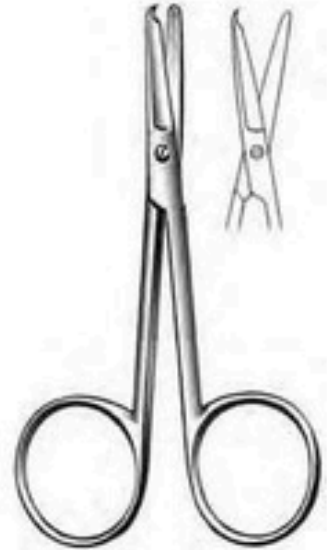

119-460



119-465



119-467

SUTURE SCISSORS

- 119-445 HEATH Suture Scissors, One Serrated Blade, 6¼" (15.9 cm)
- 119-450 ROGER Wire Scissors, Angular to Side, One Blade Serrated, 4¾" (12.1 cm)
- 119-460 SPENCER Stitch Scissors, Delicate, 3½" (8.9 cm)
- 119-465 LITTAUER JR. Stitch Scissors, Light Pattern, 4½" (11.4 cm)
- 119-467 LITTAUER Stitch Scissors, Standard Pattern, 5½" (14 cm)



119-469

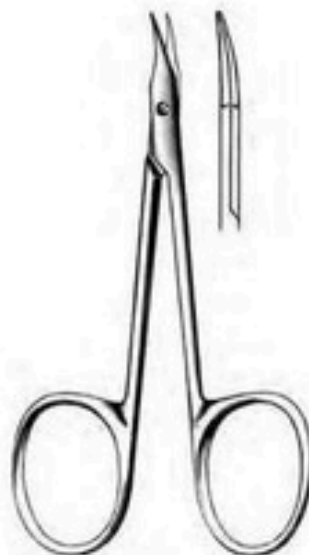

119-475



119-480



119-485

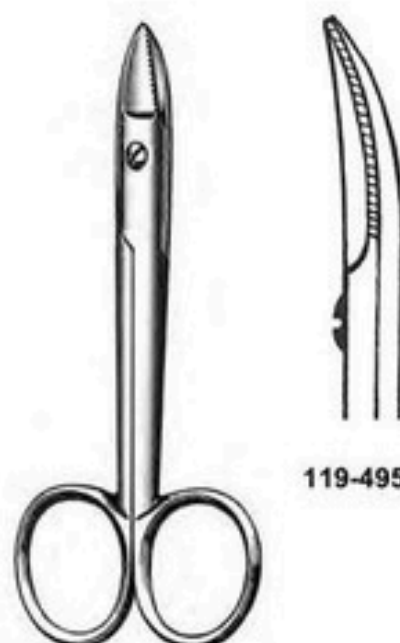

119-492

119-495

SUTURE SCISSORS

- 119-469 NEW'S Suture Scissors, Angled on Flat, 5 1/2" (14 cm)
- 119-475 GRADLE Suture Scissors, Slightly Curved, 3 3/4" (9.5 cm)
- 119-480 SHORTBENT Stitch Scissors, Curved on Side Delicate, 3 1/2" (8.9 cm)
- 119-485 NORTHBENT Stitch Scissors, Curved on Side Delicate, 4 3/4" (12.1 cm)
- 119-492 Wire Cutting Scissors, One Serrated Blade, Straight, 4 3/4" (12.1 cm)
- 119-495 Wire Cutting Scissors, One Serrated Blade, Curved, 4 3/4" (12.1 cm)



120-352



120-360



120-501



120-519



120-520
120-525

HEMOSTATIC FORCEPS

- 120-352 HARTMAN Mosquito Forceps, Straight, 3½" (8.9 cm)
- 120-360 HARTMAN Mosquito Forceps, Curved, 3½" (8.9 cm)
- 120-501 HALSTEAD Mosquito Forceps, Straight, 5" (12.7 cm)
- 120-519 HALSTEAD Mosquito Forceps, Curved, 5" (12.7 cm)
- 120-520 HALSTEAD Mosquito Forceps, Straight, Extra Delicate, 5" (12.7 cm)
- 120-525 HALSTEAD Mosquito Forceps, Curved, Extra Delicate, 5" (12.7 cm)



120-527
120-528

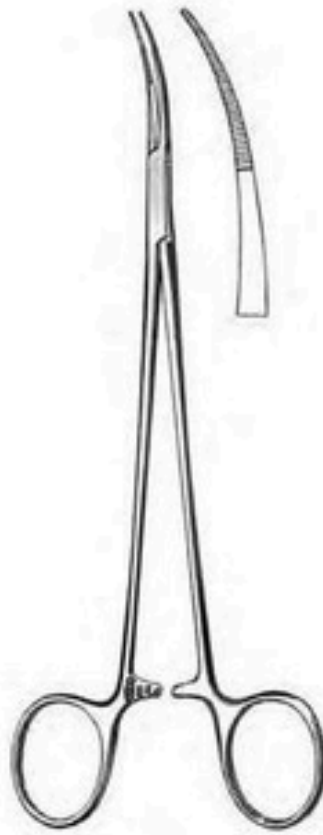

120-530

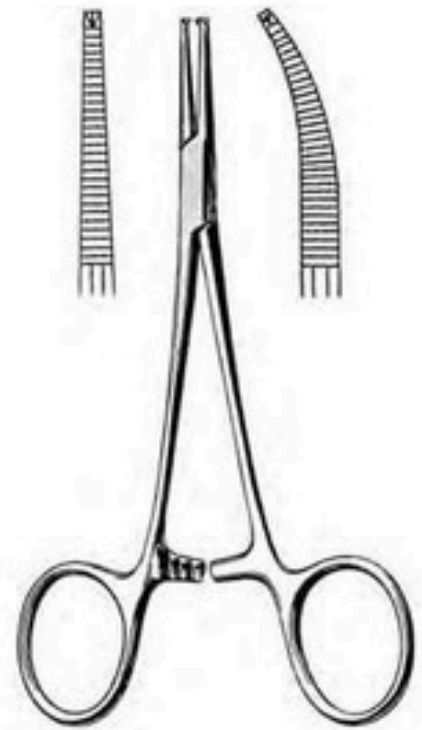

120-531
120-532

HEMOSTATIC FORCEPS

- 120-527 JACOBSON Micro Mosquito Forceps, Straight, Extremely Delicate, 5" (12.7 cm)
- 120-528 JACOBSON Micro Mosquito Forceps, Curved, Extremely Delicate, 5" (12.7 cm)
- 120-530 JACOBSON Hemostatic Forceps, Curved, Extremely Delicate, 7" (17.8 cm)
- 120-531 HALSTEAD Mosquito Forceps, Straight, 1 x 2 Teeth, 5" (12.7 cm)
- 120-532 HALSTEAD Mosquito Forceps, Curved, 1 x 2 Teeth, 5" (12.7 cm)

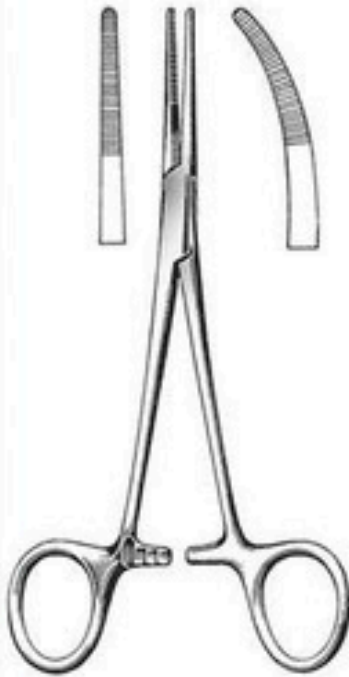

120-550
120-568

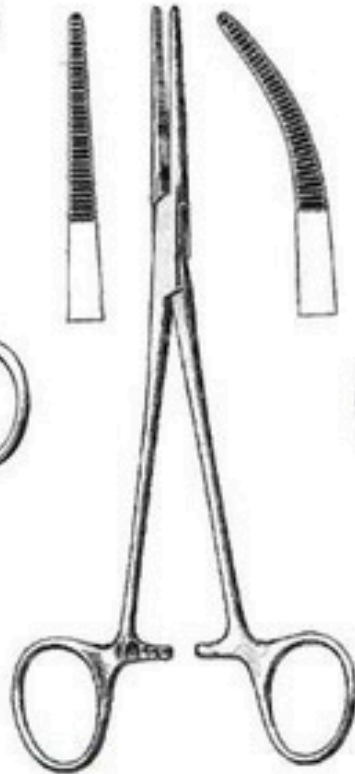

120-600
120-607

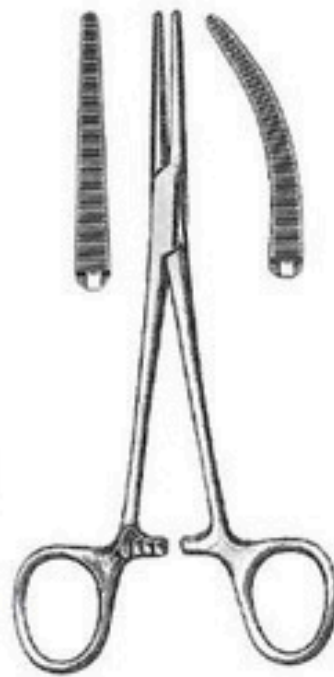

120-915
120-918

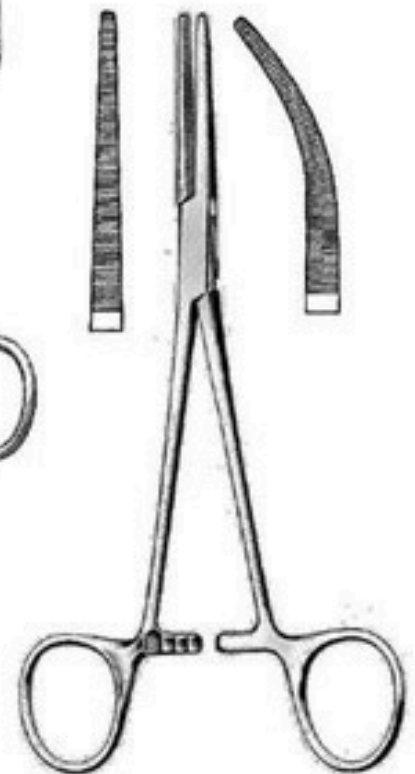

120-920
120-925

HEMOSTATIC FORCEPS

- | | |
|---------|--|
| 120-550 | KELLY Hemostatic Forceps, Straight, 5½" (14 cm) |
| 120-568 | KELLY Hemostatic Forceps, Curved, 5½" (14 cm) |
| 120-600 | RANKIN-KELLY Hemostatic Forceps, Straight, 6¼" (15.9 cm) |
| 120-607 | RANKIN-KELLY Hemostatic Forceps, Curved, 6¼" (15.9 cm) |
| 120-915 | CRILE Hemostatic Forceps, Straight, 5½" (14 cm) |
| 120-918 | CRILE Hemostatic Forceps, Curved, 5½" (14 cm) |
| 120-920 | CRILE Hemostatic Forceps, Straight, 6¼" (15.9 cm) |
| 120-925 | CRILE Hemostatic Forceps, Curved, 6¼" (15.9 cm) |



121-958
121-960



121-964
to
121-985

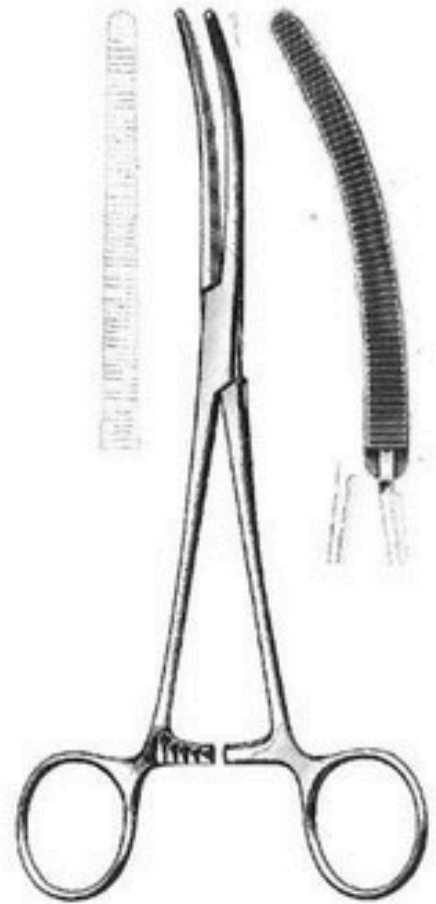

121-965
to
121-987

HEMOSTATIC FORCEPS

- | | |
|---------|--|
| 121-958 | ROCHESTER-PEAN Hemostatic Forceps, Straight, 5½" (14 cm) |
| 121-960 | ROCHESTER-PEAN Hemostatic Forceps, Curved, 5½" (14 cm) |
| 121-964 | ROCHESTER-PEAN Hemostatic Forceps, Straight, 6¼" (15.9 cm) |
| 121-965 | ROCHESTER-PEAN Hemostatic Forceps, Curved, 6¼" (15.9 cm) |
| 121-970 | ROCHESTER-PEAN Hemostatic Forceps, Straight, 7¼" (18.4 cm) |
| 121-975 | ROCHESTER-PEAN Hemostatic Forceps, Curved, 7¼" (18.4 cm) |
| 121-977 | ROCHESTER-PEAN Hemostatic Forceps, Straight, 8" (20.3 cm) |
| 121-979 | ROCHESTER-PEAN Hemostatic Forceps, Curved, 8" (20.3 cm) |
| 121-981 | ROCHESTER-PEAN Hemostatic Forceps, Straight, 9" (22.9 cm) |
| 121-983 | ROCHESTER-PEAN Hemostatic Forceps, Curved, 9" (22.9 cm) |
| 121-985 | ROCHESTER-PEAN Hemostatic Forceps, Straight, 10¼" (26 cm) |
| 121-987 | ROCHESTER-PEAN Hemostatic Forceps, Curved, 10¼" (26 cm) |

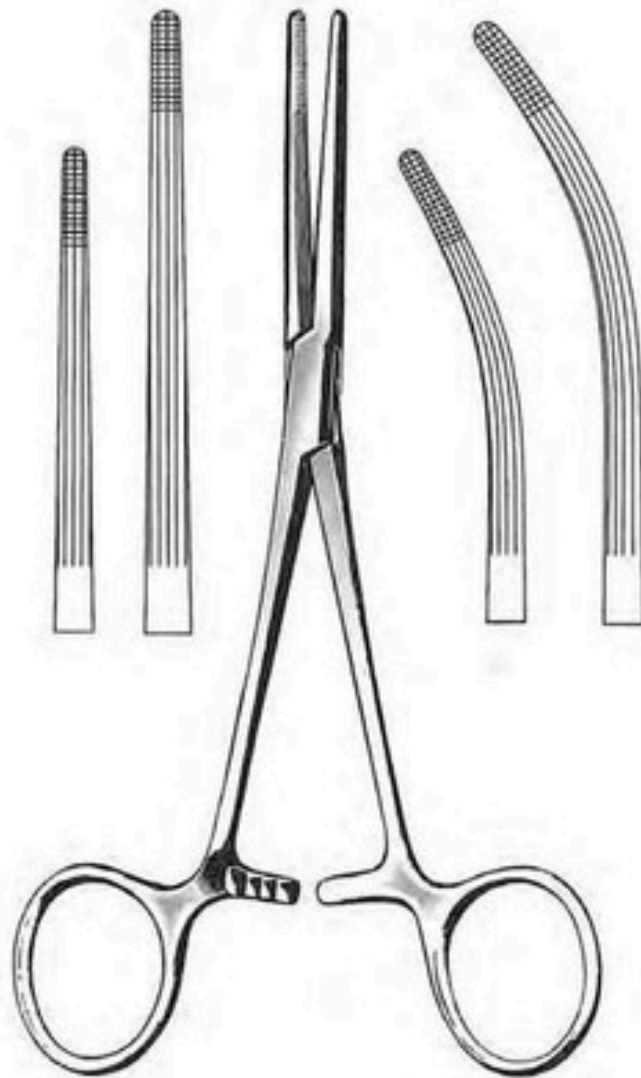

122-250
to
122-267

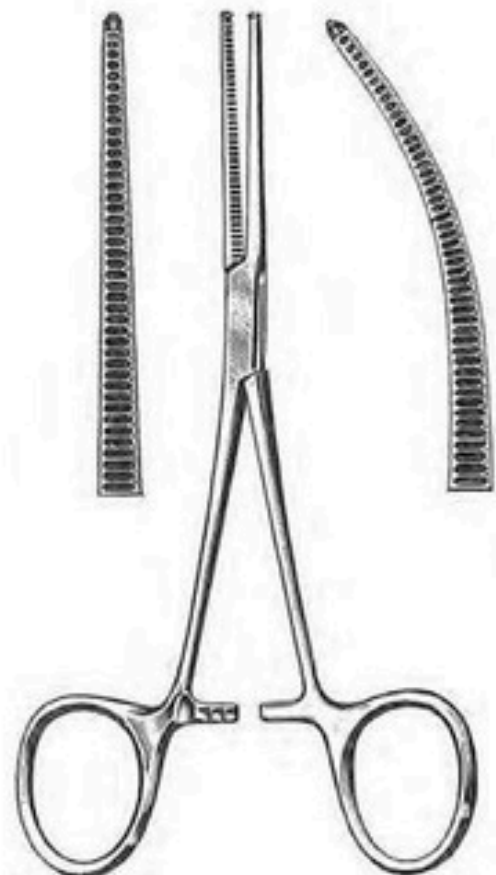

122-564
122-566

HEMOSTATIC FORCEPS

- 122-200 ROCHESTER-CARMALT Hemostatic Forceps, Straight, 6¼" (15.9 cm)
- 122-218 ROCHESTER-CARMALT Hemostatic Forceps, Curved, 6¼" (15.9 cm)
- 122-259 ROCHESTER-CARMALT Hemostatic Forceps, Straight, 8" (20.3 cm)
- 122-267 ROCHESTER-CARMALT Hemostatic Forceps, Curved, 8" (20.3 cm)

- 122-564 KOCHER Hemostatic Forceps, 1 x 2 Teeth, Straight, 5½" (14 cm)
- 122-566 KOCHER Hemostatic Forceps, 1 x 2 Teeth, Curved, 5½" (14 cm)



122-655
to
122-820

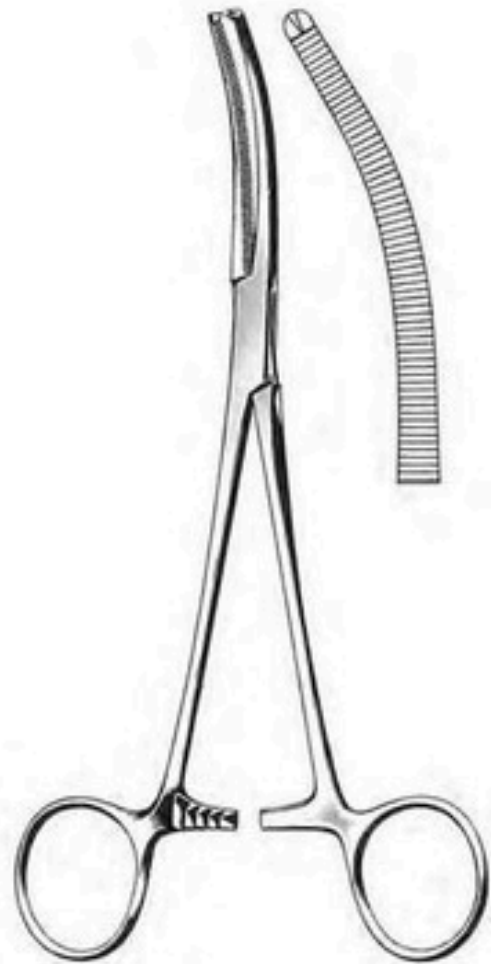

122-663
to
122-822

HEMOSTATIC FORCEPS

- | | |
|---------|--|
| 122-655 | ROCHESTER-OCHSNER Hemostatic Forceps, 1 x 2 Teeth, Straight, 6¼" (15.9 cm) |
| 122-663 | ROCHESTER-OCHSNER Hemostatic Forceps, 1 x 2 Teeth, Curved, 6¼" (15.9 cm) |
| 122-705 | ROCHESTER-OCHSNER Hemostatic Forceps, 1 x 2 Teeth, Straight, 7¼" (18.4 cm) |
| 122-755 | ROCHESTER-OCHSNER Hemostatic Forceps, 1 x 2 Teeth, Curved, 7¼" (18.4 cm) |
| 122-804 | ROCHESTER-OCHSNER Hemostatic Forceps, 1 x 2 Teeth, Straight, 8" (20.3 cm) |
| 122-812 | ROCHESTER-OCHSNER Hemostatic Forceps, 1 x 2 Teeth, Curved, 8" (20.3 cm) |
| 122-815 | ROCHESTER-OCHSNER Hemostatic Forceps, 1 x 2 Teeth, Straight, 9" (22.9 cm) |
| 122-818 | ROCHESTER-OCHSNER Hemostatic Forceps, 1 x 2 Teeth, Curved, 9" (22.9 cm) |
| 122-820 | ROCHESTER-OCHSNER Hemostatic Forceps, 1 x 2 Teeth, Straight, 10" (25.4 cm) |
| 122-822 | ROCHESTER-OCHSNER Hemostatic Forceps, 1 x 2 Teeth, Curved, 10" (25.4 cm) |

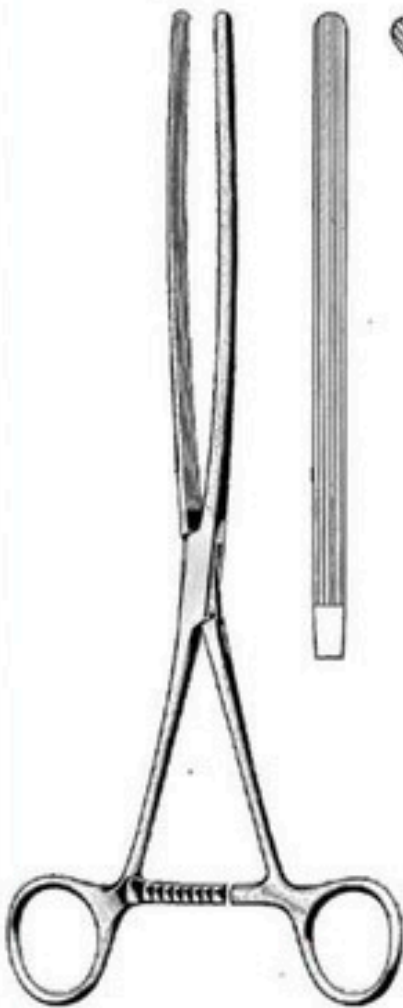

122-826
122-827

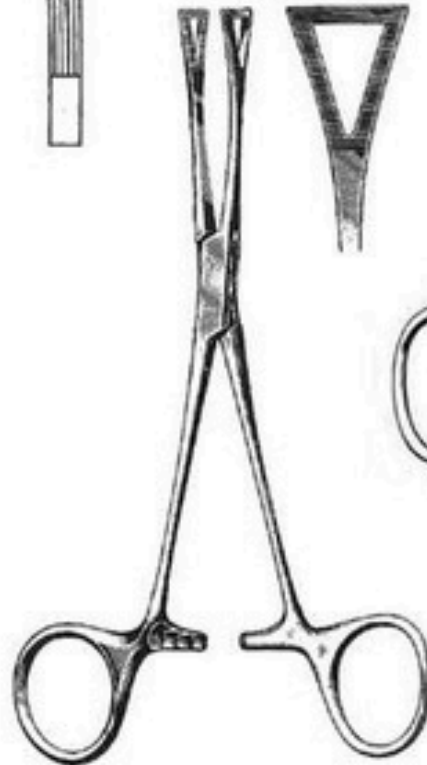
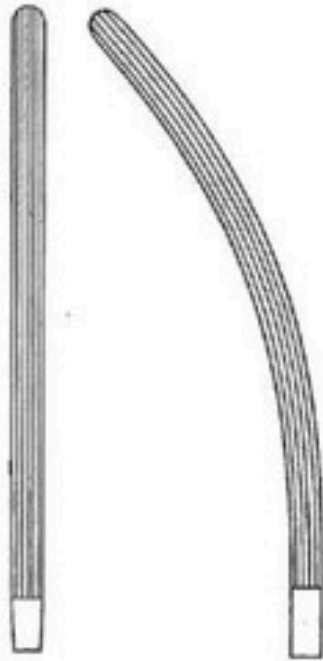

122-986



122-988

HEMOSTATIC FORCEPS

- 122-826 MAYO-ROBSON Forceps, Straight, Longitudinal Serrations, 10" (25.4 cm)
- 122-827 MAYO-ROBSON Forceps, Curved, Longitudinal Serrations, 10" (25.4 cm)
- 122-986 PENNINGTON Hemostatic Forceps, Triangular Jaws, 6" (15.2 cm)
- 122-988 PENNINGTON Hemostatic Forceps, Triangular Jaws, 8" (20.3 cm)

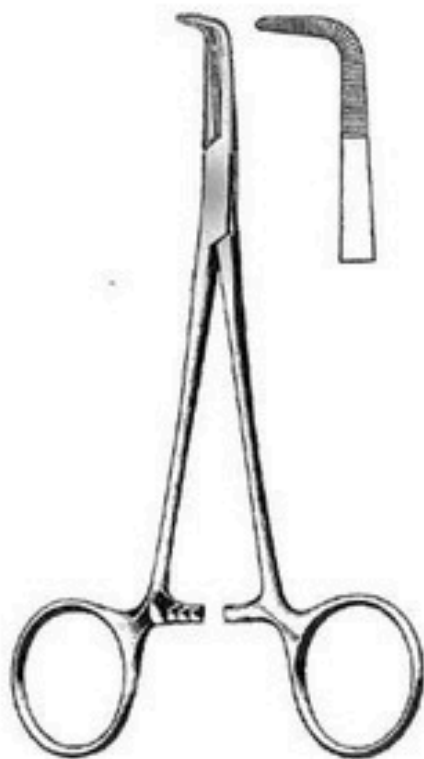

122-989

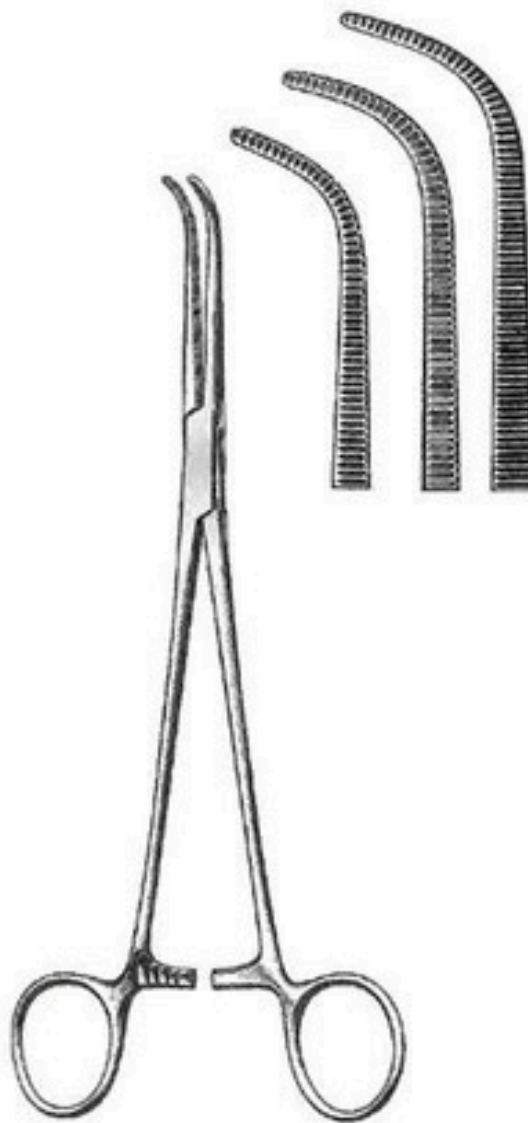

122-990
122-991
122-992

HEMOSTATIC FORCEPS

- | | |
|---------|---|
| 122-989 | Baby MIXTER Hemostatic Forceps, Fully Curved, Delicate, 5½" (14 cm) |
| 122-990 | MIXTER Hemostatic Forceps, Fully Curved, 6¼" (15.9 cm) |
| 122-991 | MIXTER Hemostatic Forceps, Fully Curved, 7¼" (18.4 cm) |
| 122-992 | MIXTER Hemostatic Forceps, Fully Curved, 9" (22.9 cm) |

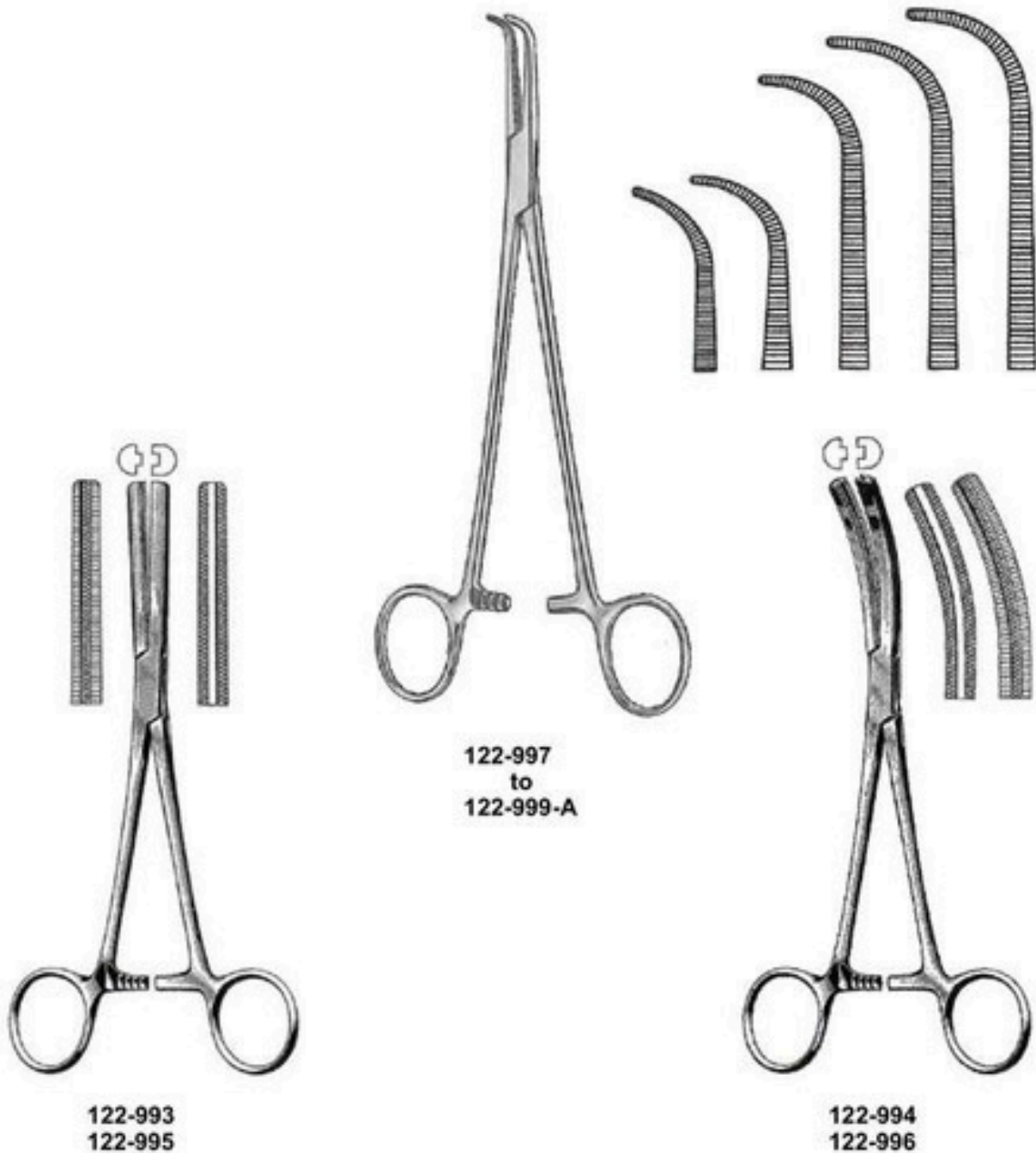

HEMOSTATIC FORCEPS

- 122-993 FERGUSON Angiotribe Forceps, Straight, 6½" (16.5 cm)
- 122-994 FERGUSON Angiotribe Forceps, Curved, 6½" (16.5 cm)
- 122-995 FERGUSON Angiotribe Forceps, Straight, 7½" (19.1 cm)
- 122-996 FERGUSON Angiotribe Forceps, Curved, 7½" (19.1 cm)
- 122-997 GEMINI-MIXTER Thoracic Forceps, Delicate, Full Curved Jaws, 5½" (14 cm)
- 122-998 GEMINI-MIXTER Thoracic Forceps, Delicate, Full Curved Jaws, 7" (17.8 cm)
- 122-998-A GEMINI-MIXTER Thoracic Forceps, Delicate, Full Curved Jaws, 8" (20.3 cm)
- 122-999 GEMINI-MIXTER Thoracic Forceps, Delicate, Full Curved Jaws, 9" (22.9 cm)
- 122-999-A GEMINI-MIXTER Thoracic Forceps, Delicate, Full Curved Jaws, 11" (27.9 cm)



123-215
123-218
123-225



123-226

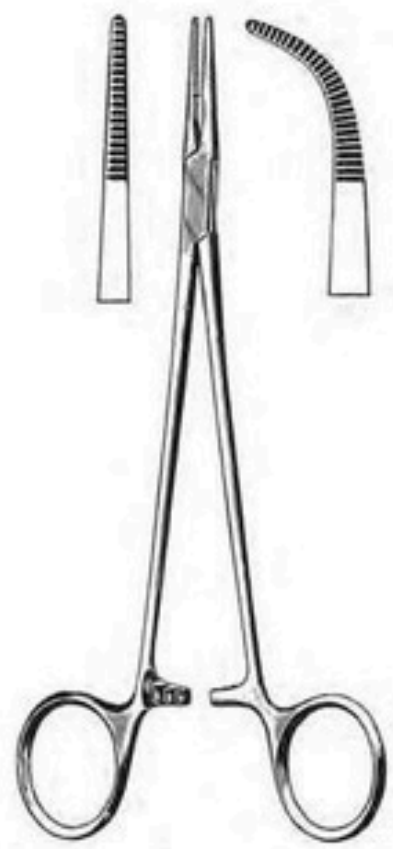

123-228
123-230

HEMOSTATIC FORCEPS

- 123-215 SCHNIDT Hemostatic Forceps, Straight, 7½" (19.1 cm)
- 123-218 SCHNIDT Hemostatic Forceps, Slight Curve, 7½" (19.1 cm)
- 123-225 SCHNIDT Hemostatic Forceps, Full Curve, 7½" (19.1 cm)

- 123-226 SAWTELL Tonsil Hemostat Forceps, Full Curve, Closed Ring, 7½" (19.1 cm)

- 123-228 ADSON Hemostatic Forceps, Straight, 7¼" (18.4 cm)
- 123-230 ADSON Hemostatic Forceps, Curved, 7¼" (18.4 cm)



124-754
124-770



124-762
124-788



124-952
124-978

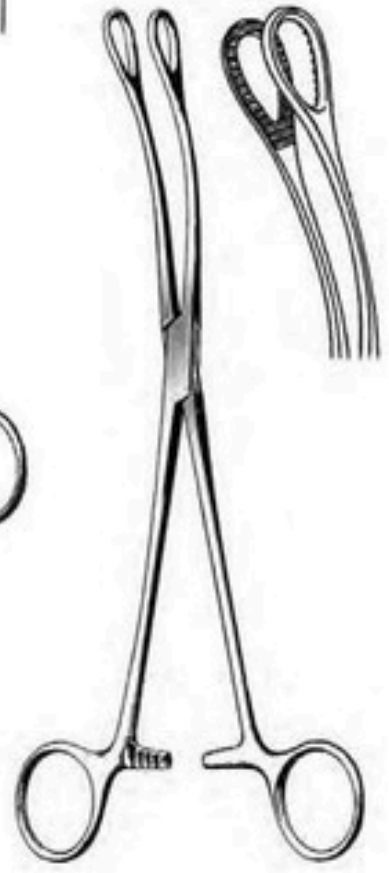

124-960
124-986

SPONGE HOLDING FORCEPS

- 124-754 BALLENGER Sponge Forceps, Straight, Serrated, 7" (17.8 cm)
- 124-762 BALLENGER Sponge Forceps, Curved, Serrated, 7" (17.8 cm)
- 124-770 BALLENGER Sponge Forceps, Straight, Smooth, 7" (17.8 cm)
- 124-788 BALLENGER Sponge Forceps, Curved, Smooth, 7" (17.8 cm)
- 124-952 FOERSTER Sponge Forceps, Straight, Serrated, 9½" (24.1 cm)
- 124-960 FOERSTER Sponge Forceps, Curved, Serrated, 9½" (24.1 cm)
- 124-978 FOERSTER Sponge Forceps, Straight, Smooth, 9½" (24.1 cm)
- 124-986 FOERSTER Sponge Forceps, Curved, Smooth, 9½" (24.1 cm)

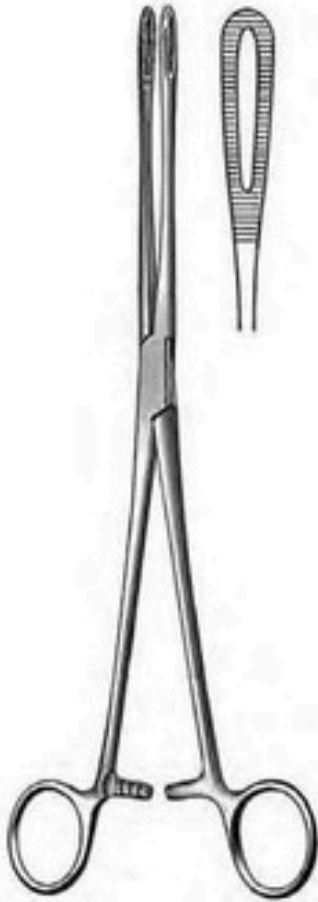

124-987

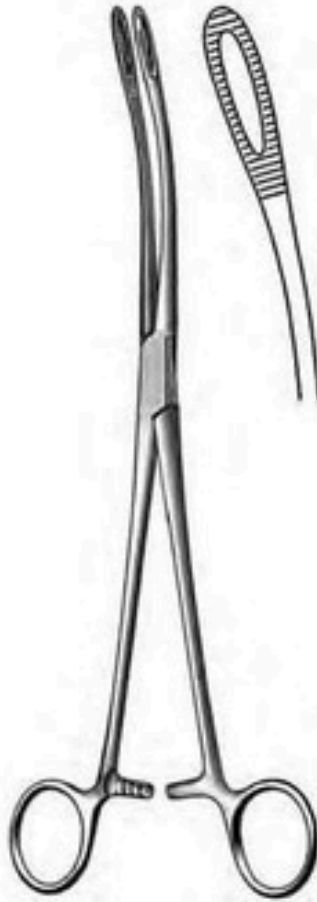

124-988

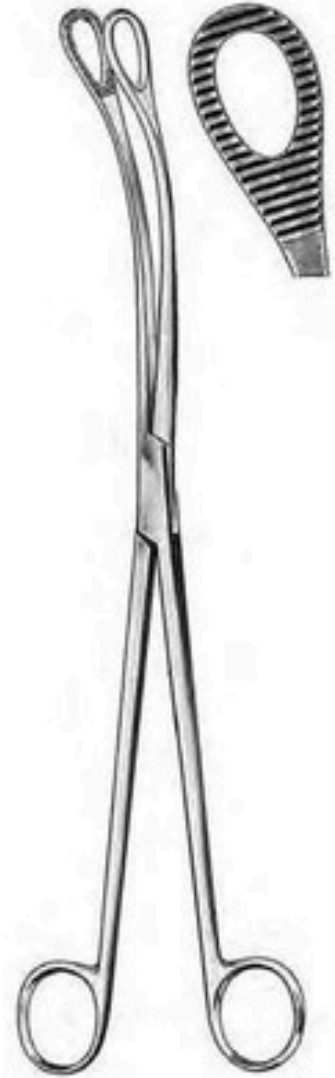

192-786

SPONGE HOLDING FORCEPS

- 124-987 FLETCHER Sponge Forceps, Straight, Serrated, 9½" (24.1 cm)
- 124-988 FLETCHER Sponge Forceps, Curved, Serrated, 9½" (24.1 cm)
- 192-786 KELLY (Placenta) Sponge Forceps, Slightly Curved, Serrated, 12½" (31.8 cm)

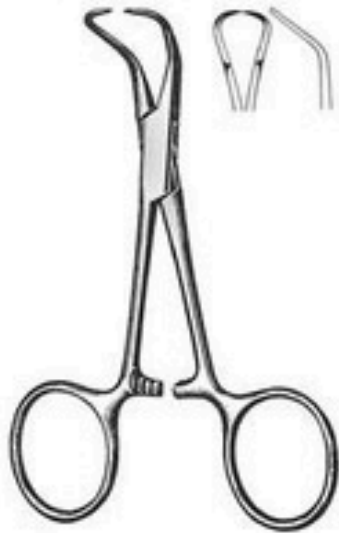

126-890

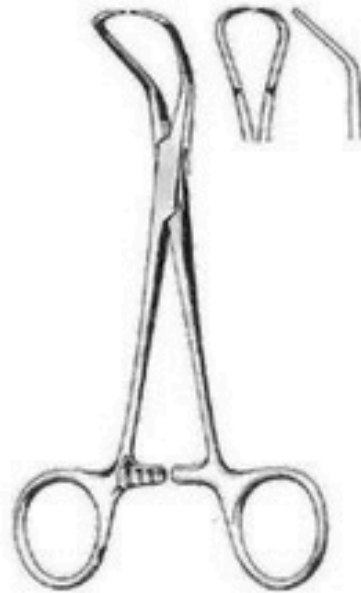

126-892



126-894



126-896
126-898

TOWEL CLAMPS

- 126-890 BACKHAUS Towel Clamp, 3½ (8.9 cm)
- 126-892 BACKHAUS Towel Clamp, 5¼" (13.3 cm)
- 126-894 ROEDER Towel Clamp, With Ball Stops, 5¼" (13.3 cm)
- 126-896 LORNA Towel Clamp, 4" (10.2 cm)
- 126-898 LORNA Towel Clamp, 5¼" (13.3 cm)



126-900



126-902

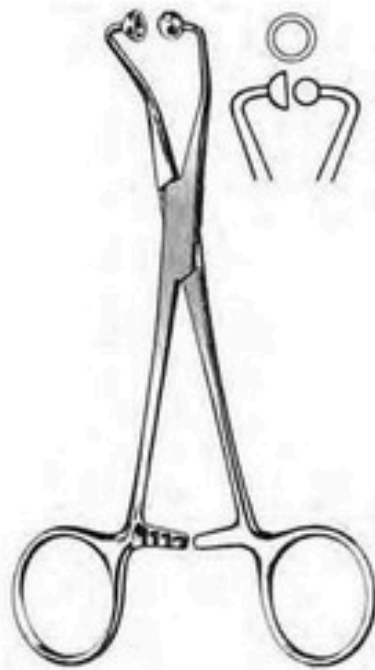

126-904
126-906

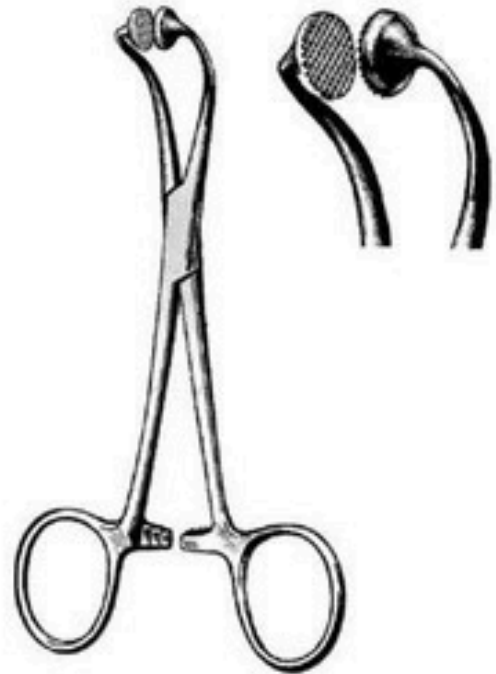

126-908
126-910

TOWEL CLAMPS

- 126-900 PEERS Towel Clamp, 5¼" (14.6 cm)
- 126-902 JONES Towel Clamp, 3½ (8.9 cm)
- 126-904 Ball and Socket Towel Clamp, 4½" (11.4 cm)
- 126-906 Ball and Socket Towel Clamp, 5½" (14 cm)
- 126-908 HOFF Towel Clamp, 4½" (11.4 cm)
- 126-910 HOFF Towel Clamp, 5¼" (13.3 cm)



128-240



128-250

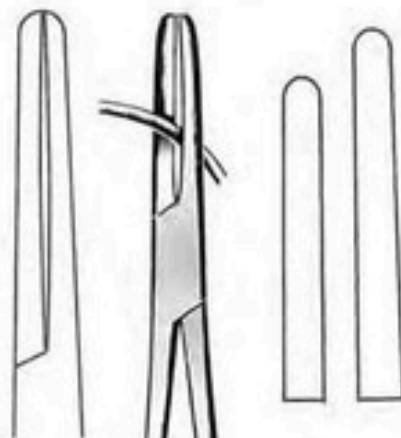

128-253
128-258

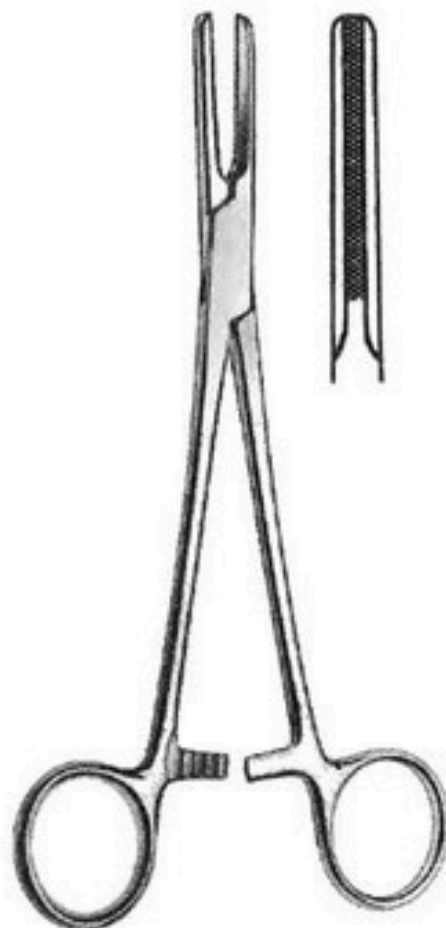
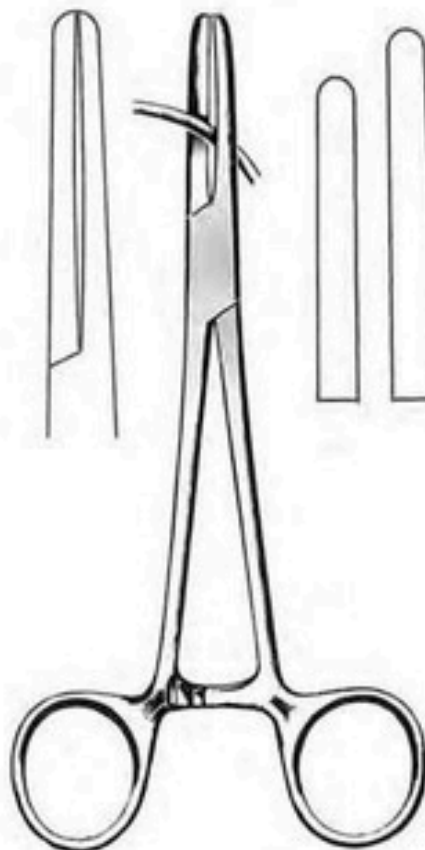

128-262
128-264
128-266

TUBE OCCLUDING CLAMPS

- | | |
|---------|--|
| 128-240 | BUNT Forceps Holder (Package of 6), With Catch, 4 $\frac{3}{4}$ " (12.1 cm) |
| 128-250 | Occlusion Clamp for Arteriovenous Cannula Cross Action, 1 $\frac{3}{4}$ " (4.5 cm) |
| 128-253 | PRESBYTERIAN Occluding Clamp, Smooth Jaws, 6 $\frac{1}{2}$ " (16.5 cm) |
| 128-258 | PRESBYTERIAN Occluding Clamp, Smooth Jaws, 7 $\frac{1}{4}$ " (18.4 cm) |
| 128-262 | VORSE Occluding Clamp, Serrated Jaws, 6 $\frac{1}{2}$ " (16.5 cm) |
| 128-264 | VORSE Occluding Clamp, Serrated Jaws, 7 $\frac{1}{2}$ " (19.1 cm) |
| 128-266 | VORSE Occluding Clamp, Serrated Jaws, 8" (20.3 cm) |

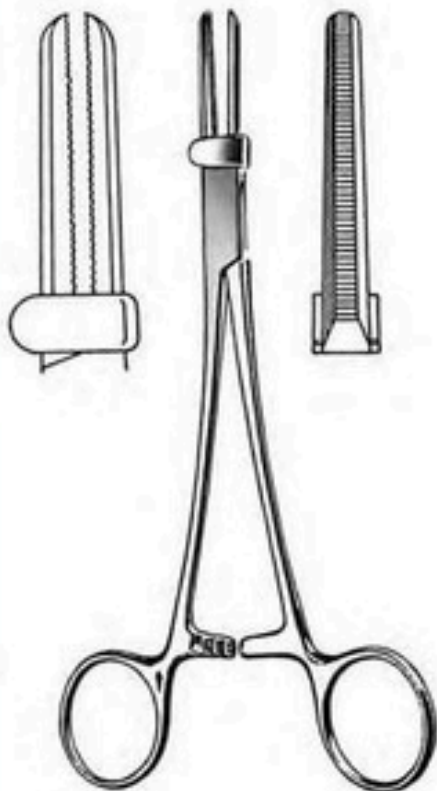

128-268
128-270
128-272



128-280



128-290

TUBE OCCLUDING CLAMPS

- | | |
|---------|---|
| 128-268 | VORSE Occluding Clamp, Serrated Jaws, With Guard, 6½" (16.5 cm) |
| 128-270 | VORSE Occluding Clamp, Serrated Jaws, With Guard, 7½" (19.1 cm) |
| 128-272 | VORSE Occluding Clamp, Serrated Jaws, With Guard, 8" (20.3 cm) |
| 128-280 | Three Prong Sterilizer Forceps, 8" (20.3 cm) |
| 128-290 | CHEATLE Sterilizer Forceps, 11" (27.9 cm) |



132-051
132-061



132-101

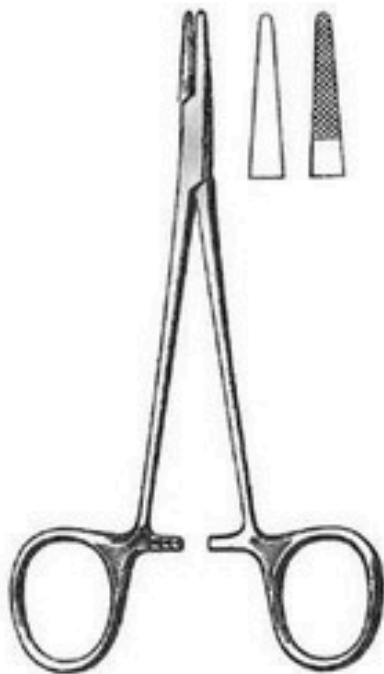

132-104
132-105



132-150

NEEDLE HOLDERS

- | | |
|---------|---|
| 132-051 | DERF Needle Holder, 4¾" (12.1 cm) |
| 132-061 | DERF Needle Holder, 4¾" (12.1 cm) delicate |
| 132-101 | WEBSTER Needle Holder, Smooth Jaws, 4¾" (12.1 cm) |
| 132-104 | HALSEY Needle Holder, Smooth Jaws, 5" (12.7 cm) |
| 132-105 | HALSEY Needle Holder, Serrated Jaws, 5" (12.7 cm) |
| 132-150 | COLLIER Needle Holder, Fenestrated Jaws, 5" (12.7 cm) |



132-200



132-366
132-465
132-473
132-480

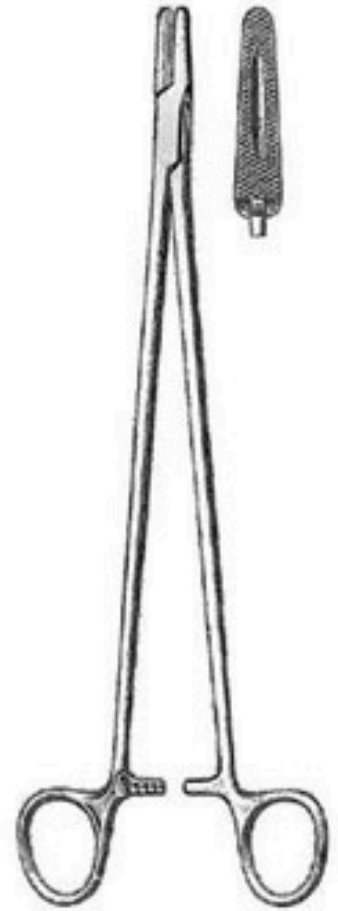

132-481

NEEDLE HOLDERS

- | | |
|---------|---|
| 132-200 | BAUMGARTNER Needle Holder, Serrated Jaws, 5½" (14 cm) |
| 132-366 | MAYO-HEGAR Needle Holder, 5½" (14 cm) |
| 132-465 | MAYO-HEGAR Needle Holder, 6" (15.2 cm) |
| 132-473 | MAYO-HEGAR Needle Holder, 7" (17.8 cm) |
| 132-480 | MAYO-HEGAR Needle Holder, 8" (20.3 cm) |
| 132-481 | MAYO-HEGAR (MASSON) Needle Holder, 10½" (26.7 cm) |



132-485
132-486
132-487
132-488



132-495

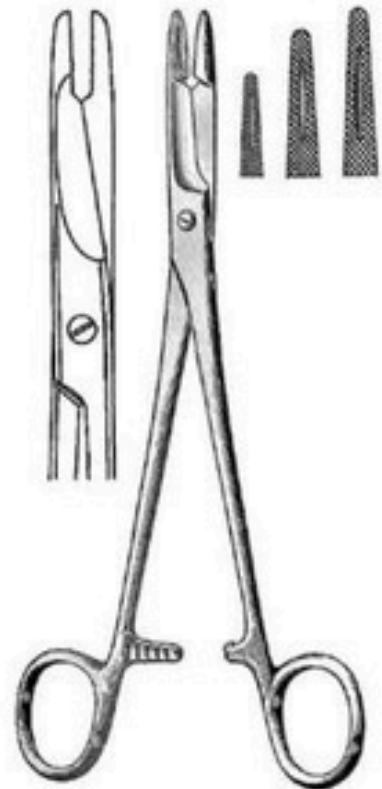

132-500
132-520
132-525

NEEDLE HOLDERS

- | | |
|---------|--|
| 132-485 | CRILE-WOOD Needle Holder, 6" (15.2 cm) |
| 132-486 | CRILE-WOOD Needle Holder, 7" (17.8 cm) |
| 132-487 | CRILE-WOOD Needle Holder, 8" (20.3 cm) |
| 132-488 | CRILE-WOOD Needle Holder, 9" (22.9 cm) |
| 132-495 | OLSEN-HEGAR Needle Holder, Extra Delicate, Serrated, 4¾" (12.1 cm) |
| 132-500 | OLSEN-HEGAR Needle Holder, Serrated, 5½" (14 cm) |
| 132-520 | OLSEN-HEGAR Needle Holder, Serrated, 6½" (16.5 cm) |
| 132-525 | OLSEN-HEGAR Needle Holder, Serrated, 7¼" (18.4 cm) |



132-555



132-558



132-566

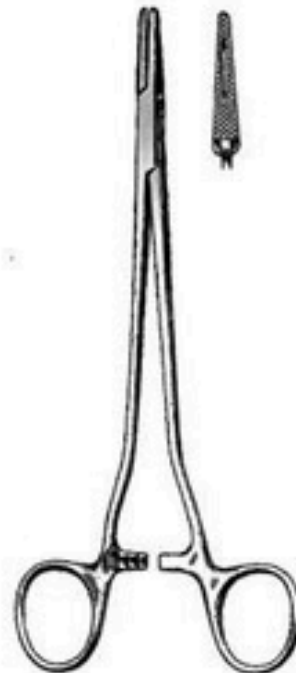

132-568

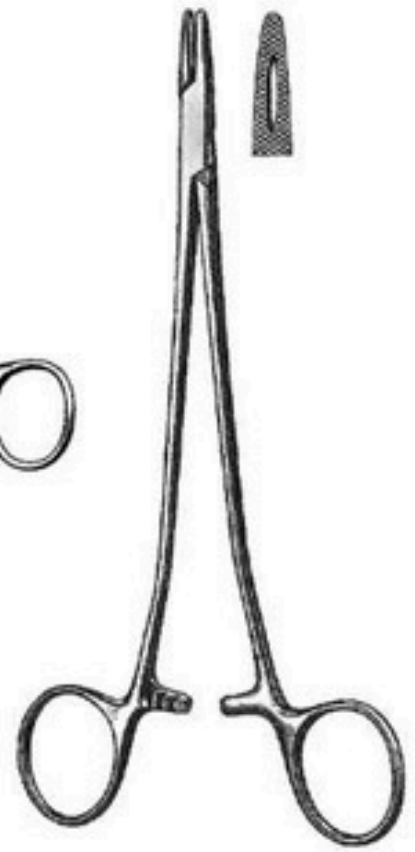

132-569

NEEDLE HOLDERS

- | | |
|---------|---|
| 132-555 | CASTROVIEJO Needle Holder, With Lock, Straight, Smooth, 5½" (14 cm) |
| 132-558 | CASTROVIEJO Needle Holder, With Lock, Straight, Serrated, 5½" (14 cm) |
| 132-566 | HEANEY Needle Holder, Curved Jaws, 8½" (21.6 cm) |
| 132-568 | SAROT Needle Holder, Light Model, 7¼" (18.4 cm) |
| 132-569 | SAROT Needle Holder, 10½" (26.7 cm) |



132-570
132-575
132-580



132-582

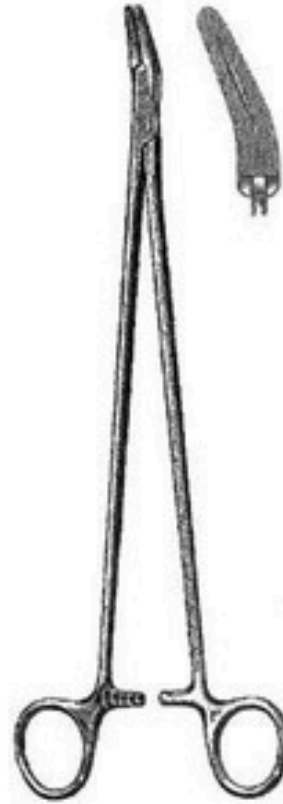

132-585

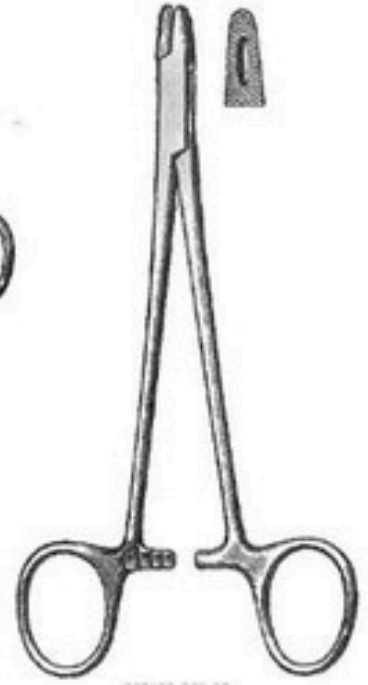

132-586

NEEDLE HOLDERS

- 132-570 MATHIEU Needle Holder, With Spring Handles, 5½" (14 cm)
- 132-575 MATHIEU Needle Holder, With Spring Handles, 6¼" (15.9 cm)
- 132-580 MATHIEU Needle Holder, With Spring Handles, 7½" (19.1 cm)
- 132-582 ADSON Needle Holder, Fenestrated Jaws, 7" (17.8 cm)
- 132-585 FINOCHIETTO Needle Holder, Angled Jaws, 10½" (26.7 cm)
- 132-586 M.G.H. Needle Holder, 7" (17.8 cm)



132-587

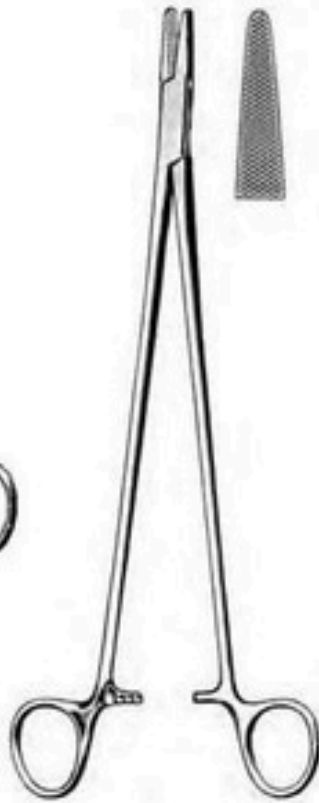

132-589



132-590



132-592



132-594



NEEDLE HOLDERS

- 132-587 WANGENSTEEN Needle Holder, Long Jaws, 10 $\frac{3}{4}$ " (27.3 cm)
132-589 WANGENSTEEN Needle Holder, Short Jaws, 10 $\frac{1}{2}$ " (26.7 cm)
132-590 BARRAQUER Needle Holder, Curved, Without lock, 10 mm Round Handles, 5" (12.7 cm)
132-592 BARRAQUER Needle Holder, Curved, With lock, 10 mm Round Handles, 5" (12.7 cm)
132-594 BARRAQUER Needle Holder, Curved, delicate, Tapered Jaws, Round Handles, Without Lock, 5 $\frac{1}{2}$ " (13 cm)



132-596

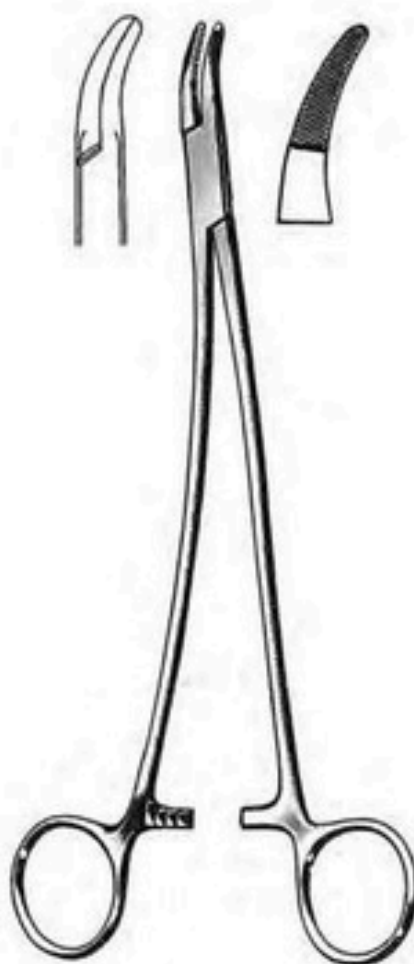

132-598

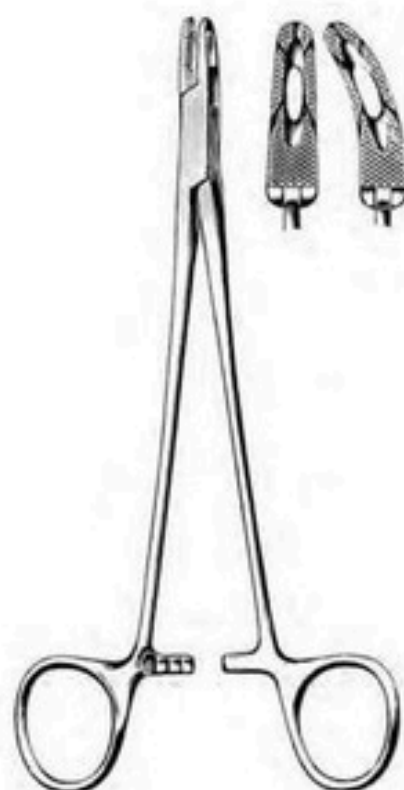

132-600
132-601

NEEDLE HOLDERS

- 132-596 NEW ORLEANS Needle Holder, 7" (17.8 cm)
- 132-598 STRATTE Needle Holder, Double Curved Jaws, Bent Shanks, 9" (22.9 cm)
- 132-600 METZENBAUM Needle Holder, Straight, Fenestrated Jaws, 7¼" (18.4 cm)
- 132-601 METZENBAUM Needle Holder, Curved, Fenestrated Jaws, 7¼" (18.4 cm)



SYSTEMS
of quality

***NEEDLE HOLDERS WITH TC-INSERTS
TUNGSTEN CARBIDE***

GENERAL SURGICAL



*Gold plated finger rings identify
these Tungsten Carbide needle
holders.*



1135-501



1135-515



1135-520



1135-525
1135-530

NEEDLE HOLDERS TUN 1TEN CARBIDE

- | | |
|----------|---|
| 1135-501 | DERF Needle Holder, Serrated Jaws, T.C. Inserts, 4¾" (12.1 cm) |
| 1135-515 | WEBSTER Needle Holder, Smooth Jaws, T.C. Inserts, 5" (12.7 cm) |
| 1135-520 | BAUMGARTNER Needle Holder, Serrated Jaws, T.C. Inserts, 5½" (14 cm) |
| 1135-525 | HALSEY Needle Holder, Smooth Jaws, T.C. Inserts, 5" (12.7 cm) |
| 1135-530 | HALSEY Needle Holder, Serrated Jaws, T.C. Inserts, 5" (12.7 cm) |



1135-534
1135-535



1135-538
to
1135-551



1135-552
1135-553



1135-554

NEEDLE HOLDERS TUN 1TEN CARBIDE

- 1135-534 CRILE-WOOD Needle Holder, Serrated Jaws, T.C. Inserts, Extra Delicate, 6" (15.2 cm)
- 1135-535 CRILE-WOOD Needle Holder, Smooth Jaws, T.C. Inserts, 6" (15.2 cm)

- 1135-538 MAYO-HEGAR Needle Holder, Serrated Jaws, T.C. Inserts, 5½" (14 cm)
- 1135-542 MAYO-HEGAR Needle Holder, Serrated Jaws, T.C. Inserts, 6" (15.2 cm)
- 1135-543 MAYO-HEGAR Needle Holder, Serrated Jaws, T.C. Inserts, Narrow jaws, 6" (15.2 cm)
- 1135-545 MAYO-HEGAR Needle Holder, Serrated Jaws, T.C. Inserts, 7" (17.8 cm)
- 1135-550 MAYO-HEGAR Needle Holder, Serrated Jaws, T.C. Inserts, 8" (20.3 cm)
- 1135-551 MAYO-HEGAR Needle Holder, Serrated Jaws, T.C. Inserts, 9" (22.9 cm)

- 1135-552 MAYO-HEGAR (MASSON) Needle Holder, Serrated Jaws, T.C. Inserts, 10½" (26.7 cm)
- 1135-553 MAYO HEGAR Needle Holder, Serrated Jaws, T.C. Inserts, 12" (30.5 cm)

- 1135-554 HEANEY Needle Holder, Curved Jaws, Serrated Jaws, T.C. Inserts, 8½" (21.6 cm)



1135-555
1135-556



1135-565
1135-570



1135-565-A
1135-570-A



1135-5711



135-572

NEEDLE HOLDERS TUN 1TEN CARBIDE

- 1135-555 SAROT Needle Holder, Light Model, Serrated Jaws, T.C. Inserts, 7 1/4" (18.4 cm)
- 1135-556 SAROT Needle Holder, Serrated Jaws, T.C. Inserts, 10 1/2" (26.7 cm)
- 1135-565 CASTROVIEJO Needle Holder, With Lock, Straight, Smooth Jaws, T.C. Inserts, 5 1/2" (14 cm)
- 1135-565-A CASTROVIEJO Needle Holder, With Lock, Curved, Smooth Jaws, T.C. Inserts, 5 1/2" (14 cm)
- 1135-570 CASTROVIEJO Needle Holder, With Lock, Straight, Serrated Jaws, T.C. Inserts, 5 1/2" (14 cm)
- 1135-570-A CASTROVIEJO Needle Holder, With Lock, Curved, Serrated Jaws, T.C. Inserts, 5 1/2" (14 cm)
- 1135-571 JACOBSON Needle Holder, With Lock, Straight, Serrated Jaws, T.C. Inserts, 7" (17.8 cm)
- 1135-572 JACOBSON Needle Holder, With Lock, Curved, Serrated Jaws, T.C. Inserts, 7" (17.8 cm)



1135-573
1135-574



1135-574-A
1135-575
1135-580



1135-582
to
1135-589



1135-590
to
1135-595

NEEDLE HOLDERS TUN 1TEN CARBIDE

- 1135-573 OLSEN-HEGAR Needle Holder, With Suture Scissors, Extra Delicate, Smooth Jaws, T.C. Inserts, 4 3/4" (12.1 cm)
- 1135-574 OLSEN-HEGAR Needle Holder, With Suture Scissors, Extra Delicate, Serrated Jaws, T.C. Inserts, 4 3/4" (12.1 cm)
- 1135-574-A OLSEN-HEGAR Needle Holder, With Suture Scissors, Serrated Jaws, T.C. Inserts, 5 1/2" (14 cm)
- 1135-575 OLSEN-HEGAR Needle Holder, With Suture Scissors, Serrated Jaws, T.C. Inserts, 6 1/2" (16.5 cm)
- 1135-580 OLSEN-HEGAR Needle Holder, With Suture Scissors, Serrated Jaws, T.C. Inserts, 7 1/2" (19.1 cm)
- 1135-582 CRILE-WOOD (DeBAKEY) Needle Holder, Serrated Jaws, T.C. Inserts, 7" (17.8 cm)
- 1135-583 CRILE-WOOD (DeBAKEY) Needle Holder, Serrated Jaws, T.C. Inserts, 8" (20.3 cm)
- 1135-585 CRILE-WOOD (DeBAKEY) Needle Holder, Serrated Jaws, T.C. Inserts, 9" (22.9 cm)
- 1135-588 CRILE-WOOD (DeBAKEY) Needle Holder, Serrated Jaws, T.C. Inserts, 10 1/2" (26.7 cm)
- 1135-589 CRILE-WOOD (DeBAKEY) Needle Holder, Serrated Jaws, T.C. Inserts, 12" (30.5 cm)
- 1135-590 KALMAN (RYDER) Needle Holder, Serrated Jaws, T.C. Inserts, 5" (12.7 cm)
- 1135-591 KALMAN (RYDER) Needle Holder, Serrated Jaws, T.C. Inserts, 6" (15.2 cm)
- 1135-592 KALMAN (RYDER) Needle Holder, Serrated Jaws, T.C. Inserts, 7" (17.8 cm)
- 1135-595 KALMAN (RYDER) Needle Holder, Serrated Jaws, T.C. Inserts, 9" (22.9 cm)



1135-596



1135-598
135-600
135-605



135-610
135-615

NEEDLE HOLDERS TUN 1TEN CARBIDE

- 1135-596 STRATTE Needle Holder, Serrated Jaws, Double Curved, Bent Shanks, T.C. Inserts, 9" (22.9 cm)
- 1135-598 MATHIEU Needle Holder, Single Spring, Serrated Jaws, T.C. Inserts, 5½" (14 cm)
- 135-600 MATHIEU Needle Holder, Single Spring, Serrated Jaws, T.C. Inserts, 6¼" (15.9 cm)
- 135-605 MATHIEU Needle Holder, Single Spring, Serrated Jaws, T.C. Inserts, 7½" (19.1 cm)
- 135-610 Wire Twister, Serrated Jaws, T.C. Inserts, 6" (15.2 cm)
- 135-615 Wire Twister, Extra Heavy, Serrated Jaws, T.C. Inserts, 8" (20.3 cm)



140-700
to
140-710



140-710-



TCI 40724075
140-718



140-7201 40-7221 40-725



DRESSING FORCEPS

- 140-700 Dressing Forceps, Serrated, 4½" (11.4 cm)
- 140-705 Dressing Forceps, Serrated, 5" (12.7 cm)
- 140-708 Dressing Forceps, Serrated, 5½" (14 cm)
- 140-710 Dressing Forceps, Serrated, 6" (15.2 cm)

- 140-710-TC Dressing Forceps, T.C. Jaws, Serrated, 6" (15.2 cm)

- 140-712 Dressing Forceps, Serrated, 8" (20.3 cm)
- 140-715 Dressing Forceps, Serrated, 10" (25.4 cm)
- 140-718 Dressing Forceps, Serrated, 12" (30.5 cm)

- 140-720 Eye Dressing Forceps, Straight, Extra Fine, Serrated, 4" (10.2 cm)
- 140-722 Eye Dressing Forceps, Half Curved, Extra Fine, Serrated, 4" (10.2 cm)
- 140-725 Eye Dressing Forceps, Full Curved, Extra Fine, Serrated, 4" (10.2 cm)



145-800
to
145-810

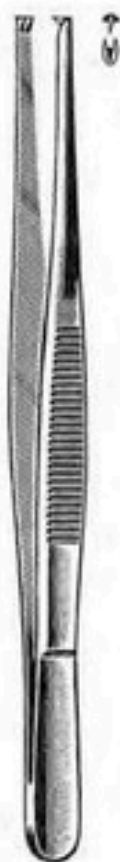

145-815
145-818
145-819



145-830
to
145-835



145-836
to
145-841



145-842
to
145-848

TISSUE FORCEPS

- | | |
|---------|--|
| 145-800 | Tissue Forceps, 1 x 2 Teeth, 4½" (11.4 cm) |
| 145-805 | Tissue Forceps, 1 x 2 Teeth, 5" (12.7 cm) |
| 145-808 | Tissue Forceps, 1 x 2 Teeth, 5½" (14 cm) |
| 145-810 | Tissue Forceps, 1 x 2 Teeth, 6" (15.2 cm) |
| 145-815 | Tissue Forceps, 1 x 2 Teeth, 8" (20.3 cm) |
| 145-818 | Tissue Forceps, 1 x 2 Teeth, 10" (25.4 cm) |
| 145-819 | Tissue Forceps, 1 x 2 Teeth, 12" (30.5 cm) |
| 145-830 | Tissue Forceps, 2 x 3 Teeth, 5" (12.7 cm) |
| 145-832 | Tissue Forceps, 2 x 3 Teeth, 5½" (14 cm) |
| 145-834 | Tissue Forceps, 2 x 3 Teeth, 6" (15.2 cm) |
| 145-835 | Tissue Forceps, 2 x 3 Teeth, 8" (20.3 cm) |
| 145-836 | Tissue Forceps, 3 x 4 Teeth, 5" (12.7 cm) |
| 145-838 | Tissue Forceps, 3 x 4 Teeth, 5½" (14 cm) |
| 145-840 | Tissue Forceps, 3 x 4 Teeth, 6" (15.2 cm) |
| 145-841 | Tissue Forceps, 3 x 4 Teeth, 8" (20.3 cm) |
| 145-842 | Tissue Forceps, 4 x 5 Teeth, 5" (12.7 cm) |
| 145-844 | Tissue Forceps, 4 x 5 Teeth, 5½" (14 cm) |
| 145-846 | Tissue Forceps, 4 x 5 Teeth, 6" (15.2 cm) |
| 145-848 | Tissue Forceps, 4 x 5 Teeth, 8" (20.3 cm) |



145-820



145-822



145-825

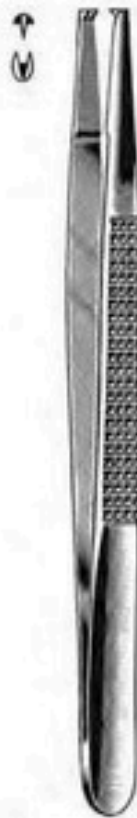

145-850
145-851



145-860



145-861

TISSUE FORCEPS

- 145-820 IRIS Tissue Forceps, Straight, Extra Fine, 1 x 2 Teeth, 4" (10.2 cm)
- 145-822 IRIS Tissue Forceps, Half Curved, Extra Fine, 1 x 2 Teeth, 4" (10.2 cm)
- 145-825 IRIS Tissue Forceps, Full Curved, Extra Fine, 1 x 2 Teeth, 4" (10.2 cm)
- 145-850 BONNEY Tissue Forceps, 1 x 2 Teeth and Serrated Tips, 7" (17.8 cm)
- 145-851 BONNEY Tissue Forceps, 2 x 3 Teeth and Serrated Tips, 7" (17.8 cm)
- 145-860 FERRIS-SMITH Tissue Forceps, Serrated Platform Tips with 1 x 2 Teeth, 7" (17.8 cm)
- 145-861 FERRIS-SMITH Tissue Forceps, Serrated Platform Tips with 2 x 3 Teeth, 7" (17.8 cm)



150-315



150-325



150-330



150-335



150-336



150-337

DRESSING AND TISSUE FORCEPS

- 150-315 ADSON Dressing Forceps, Serrated, 4 3/4" (12.1 cm)
- 150-325 ADSON Tissue Forceps, 1 x 2 Teeth, 4 3/4" (12.1 cm)
- 150-330 ADSON Micro Dressing Forceps, Serrated, Delicate, 4 3/4" (12.1 cm)
- 150-335 ADSON Tissue Forceps, 1 x 2 Teeth, Delicate, 4 3/4" (12.1 cm)
- 150-336 ADSON Tissue Forceps, 2 x 3 Teeth, Delicate, 4 3/4" (12.1 cm)
- 150-337 ADSON Dressing Forceps, Serrated, Lightweight Fenestrated, 4 3/4" (12.1 cm)



SYSTEMS

of quality

GENERAL SURGICAL



150-338



150-345



150-355



150-357



150-360



150-365

DRESSING AND TISSUE FORCEPS

- 150-338 ADSON Tissue Forceps, 1 x 2 Teeth, Lightweight Fenestrated, 4¾" (12.1 cm)
- 150-345 ADSON Dressing Forceps, Serrated, T.C., 4¾" (12.1 cm)
- 150-355 BROWN-ADSON Tissue Forceps, 7 x 7 Side Grasping Teeth, 4¾" (12.1 cm)
- 150-357 BROWN Tissue Forceps, 8 x 8 Teeth, With Side Grasping Teeth, 6" (15.2 cm)
- 150-360 ADSON Tissue Forceps, 1 x 2 Teeth, Smooth Tying Platform, 4¾" (12.1 cm)
- 150-365 ADSON Tissue Forceps, 1 x 2 Teeth, Smooth Tying Platform, Fenestrated, 4¾" (12.1 cm)



150-366



150-367



160-425



160-430

DRESSING AND TISSUE FORCEPS

- 150-366 HUDSON (EWALD) Dressing Forceps, Serrated, 4 $\frac{3}{4}$ " (12.1 cm)
- 150-367 HUDSON (EWALD) Tissue Forceps, 1 x 2 Teeth, 4 $\frac{3}{4}$ " (12.1 cm)
- 160-425 Micro ADSON Dressing Forceps, Serrated Tips 0.5 mm Wide, 4 $\frac{3}{4}$ " (12.1 cm)
- 160-430 Micro ADSON Tissue Forceps, 1 x 2 Teeth, Tips 0.5 mm Wide, 4 $\frac{3}{4}$ " (12.1 cm)



150-370
150-372
150-374



150-376



150-380
to
150-383



150-384
to
150-387

DRESSING AND TISSUE FORCEPS

- 150-370 RUSSIAN Tissue Forceps, 6" (15.2 cm)
- 150-372 RUSSIAN Tissue Forceps, 8" (20.3 cm)
- 150-374 RUSSIAN Tissue Forceps, 10" (25.4 cm)

- 150-376 SINGLEY Tissue Forceps, Fenestrated Serrated Jaws, 9" (22.9 cm)

- 150-380 POTTS-SMITH Dressing Forceps, Serrated, 7" (17.8 cm)
- 150-381 POTTS-SMITH Dressing Forceps, Serrated, 8¼" (21 cm)
- 150-382 POTTS-SMITH Dressing Forceps, Serrated, 9½" (24.1 cm)
- 150-383 POTTS-SMITH Dressing Forceps, Serrated, 12" (30.5 cm)

- 150-384 POTTS-SMITH Tissue Forceps, 1 x 2 Teeth, Serrated, 7" (17.8 cm)
- 150-385 POTTS-SMITH Tissue Forceps, 1 x 2 Teeth, Serrated, 8¼" (21 cm)
- 150-386 POTTS-SMITH Tissue Forceps, 1 x 2 Teeth, Serrated, 9½" (24.1 cm)
- 150-387 POTTS-SMITH Tissue Forceps, 1 x 2 Teeth, Serrated, 12" (30.5 cm)



150-400

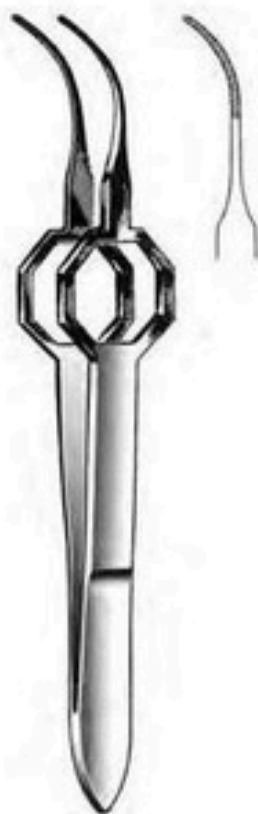

150-405



150-410



150-415

DRESSING AND TISSUE FORCEPS

- | | |
|---------|---|
| 150-400 | FOERSTER Eye Dressing Forceps, Straight, Serrated, 3¼" (9.5 cm) |
| 150-405 | FOERSTER Eye Dressing Forceps, Curved, Serrated, 3¼" (9.5 cm) |
| 150-410 | FOERSTER IRIS Tissue Forceps, Straight, 1 x 2 Teeth, 3¼" (9.5 cm) |
| 150-415 | FOERSTER IRIS Tissue Forceps, Curved, 1 x 2 Teeth, 3¼" (9.5 cm) |



150-420
150-425
150-430



150-432



150-433



150-435



150-440

DRESSING AND TISSUE FORCEPS

- 150-420 DESMARRES Chalazion Forceps, small size, inside ring 11 x 17 mm, 3½" (8.9 cm)
- 150-425 DESMARRES Chalazion Forceps, medium size, inside ring 12 x 23 mm, 3½" (8.9 cm)
- 150-430 DESMARRES Chalazion Forceps, large size, inside ring 17 x 28 mm, 3½" (8.9 cm)
- 150-432 BISHOP-HARMON Dressing Forceps, Serrated, 0.5 mm wide, 3½" (8.9 cm)
- 150-433 BISHOP-HARMON Tissue Forceps, 1 x 2 Teeth, 0.5 mm wide, 3½" (8.9 cm)
- 150-435 BISHOP-HARMON Dressing Forceps, Serrated, 0.8 mm wide, 3½" (8.9 cm)
- 150-440 BISHOP-HARMON Tissue Forceps, 1 x 2 Teeth, 0.8 mm wide, 3½" (8.9 cm)



1.5 mm

155-550
to
155-565



2.0 mm

155-566
to
155-569



2.5 mm

155-570
to
155-590



3.5 mm

155-595
to
155-610

ATRAUMATIC AND CARDIOVASCULAR INSTRUMENTS

- | | |
|---------|---|
| 155-550 | DeBAKEY Thoracic Tissue Forceps, 1.5 mm Jaws, 6¼" (15.9 cm) |
| 155-555 | DeBAKEY Thoracic Tissue Forceps, 1.5 mm Jaws, 8" (20.3 cm) |
| 155-560 | DeBAKEY Thoracic Tissue Forceps, 1.5 mm Jaws, 9½" (24.1 cm) |
| 155-565 | DeBAKEY Thoracic Tissue Forceps, 1.5 mm Jaws, 12" (30.5 cm) |
| 155-566 | DeBAKEY Thoracic Tissue Forceps, 2 mm Jaws, 6¼" (15.9 cm) |
| 155-567 | DeBAKEY Thoracic Tissue Forceps, 2 mm Jaws, 8" (20.3 cm) |
| 155-568 | DeBAKEY Thoracic Tissue Forceps, 2 mm Jaws, 9½" (24.1 cm) |
| 155-569 | DeBAKEY Thoracic Tissue Forceps, 2 mm Jaws, 12" (30.5 cm) |
| 155-570 | DeBAKEY Thoracic Tissue Forceps, 2.5 mm Jaws, 6¼" (15.9 cm) |
| 155-575 | DeBAKEY Thoracic Tissue Forceps, 2.5 mm Jaws, 8" (20.3 cm) |
| 155-580 | DeBAKEY Thoracic Tissue Forceps, 2.5 mm Jaws, 9½" (24.1 cm) |
| 155-590 | DeBAKEY Thoracic Tissue Forceps, 2.5 mm Jaws, 12" (30.5 cm) |
| 155-595 | DeBAKEY Thoracic Tissue Forceps, 3.5 mm Jaws, 6¼" (15.9 cm) |
| 155-600 | DeBAKEY Thoracic Tissue Forceps, 3.5 mm Jaws, 8" (20.3 cm) |
| 155-605 | DeBAKEY Thoracic Tissue Forceps, 3.5 mm Jaws, 9½" (24.1 cm) |
| 155-610 | DeBAKEY Thoracic Tissue Forceps, 3.5 mm Jaws, 12" (30.5 cm) |



155-650
155-652



155-653



155-660
155-662
155-664



155-670

ATRAUMATIC AND CARDIOVASCULAR INSTRUMENTS

- 155-650 COLLIN (Intestinal) Forceps, 1/2" (13 mm) Wide Jaws, 8" (20.3 cm)
- 155-652 COLLIN (Intestinal) Forceps, 1" (25 mm) Wide Jaws, 8" (20.3 cm)
- 155-653 COLLIN-DUVAL Lung Grasping Forceps, 1/2" (13 mm) Wide Jaws, 8" (20.3 cm)
- 155-660 SATINSKY-DeBAKEY Vena Cava Clamp, Small, 9 3/4" (24.8 cm)
- 155-662 SATINSKY-DeBAKEY Vena Cava Clamp, Medium, 9 3/4" (24.8 cm)
- 155-664 SATINSKY-DeBAKEY Vena Cava Clamp, Large, 9 3/4" (24.8 cm)
- 155-670 SAROT (CRAFOORD) Artery Thoracic Forceps, 9 1/2" (24.1 cm)

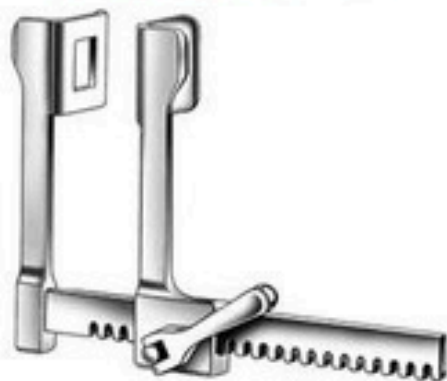

155-680

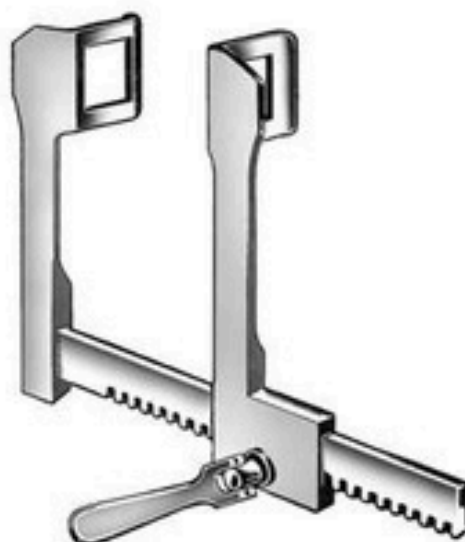

155-682
to
155-688



155-689
to
155-694

THORACIC CARDIOVASCULAR INSTRUMENTS RIB SPREADERS

- 155-680 FINOCHIETTO-DeBAKEY Infant Rib Spreader, Blades 19 mm Deep x 21 mm Wide, 3.35" (8.5 cm) Spread, (661-200)
- 155-682 FINOCHIETTO Rib Spreader, Child Size, Blades 38 mm Deep x 45 mm Wide, 6" (15.2 cm) Spread, Straight Arms, (661-203)
- 155-684 FINOCHIETTO Rib Spreader, Standard Size, Blades 48 mm Deep x 65 mm Wide, 8" (20.3 cm) Spread, Straight Arms, (661-204)
- 155-686 FINOCHIETTO Rib Spreader, Standard Size, Blades 48 mm Deep x 65 mm Wide, 10" (25.4 cm) Spread, Straight Arms, (661-205)
- 155-688 FINOCHIETTO Rib Spreader, Standard Size, Blades 48 mm Deep x 65 mm Wide, 12" (30.5 cm) Spread, Straight Arms, (661-206)

- 155-689 FINOCHIETTO Rib Spreader, Curved Arms, Blades 38 mm Deep x 45 mm wide, 6" (15.2 cm) Spread, Standard Size, (662-052)
- 155-690 FINOCHIETTO Rib Spreader, Curved Arms, Blades 48 mm Deep x 65 mm Wide, 8" (20.3 cm) Spread, Standard Size, (662-054)
- 155-692 FINOCHIETTO Rib Spreader, Curved Arms, Blades 48 mm Deep x 65 mm Wide, 10" (25.4 cm) Spread, Standard Size, (662-056)
- 155-694 FINOCHIETTO Rib Spreader, Curved Arms, Blades 48 mm Deep x 65 mm Wide, 12" (30.5 cm) Spread, Standard Size, 662-106)



155-696
155-698



155-700

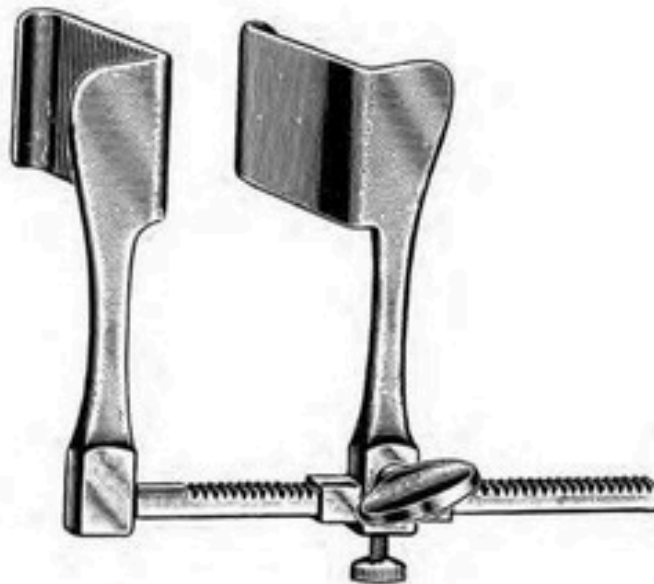

155-702

THORACIC CARDIOVASCULAR INSTRUMENTS

- 155-696 Haight Baby Rib Spreader, 2½" (6.4 cm) Arms, 32 x 32 mm Blades, 4 ½" (11.4 cm) Spread
- 155-698 Haight Baby Rib Spreader, 3½" (9 cm) Arms, 32 x 32 mm Blades, 4 ½" (11.4 cm) Spread
- 155-700 Badgley Rib Spreader, 4 x 4 Blunt Teeth, 2" x 1¼" (5.1 x 4.4 cm), 6½" (16.5 cm) Spread
- 155-702 Tuffier Rib Spreader, 2" x 1¼" (5.1 x 4.4 cm), Grooved Blades, 6½" (16.5 cm) Spread (662-254)



156-372
156-374

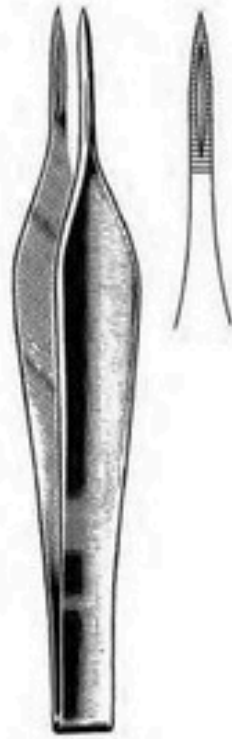

156-376
156-378



156-380



156-382

SPLINTER FORCEPS

- | | |
|---------|---|
| 156-372 | Plain Splinter Forceps, 3½" (8.9 cm) |
| 156-374 | Plain Splinter Forceps, 4½" (11.4 cm) |
| 156-376 | FEILCHENFELD Splinter Forceps, 3" (7.6 cm) |
| 156-378 | FEILCHENFELD Splinter Forceps, 4½" (11.4 cm) |
| 156-380 | CARMALT Splinter Forceps, Straight, 4¼" (10.8 cm) |
| 156-382 | CARMALT Splinter Forceps, Curved, 4¼" (10.8 cm) |



160-400



160-402



160-4041 60-4061 60-408



160-410



160-412

MICRO SURGERY INSTRUMENTS

SWISS JEWELER STYLE FORCEPS Non-Magnetic Stainless Steel

- 160-400** Swiss Jeweler Style Forceps, Style 1, Straight, Fine Points, 4¾" (12.1 cm)
- 160-402** Swiss Jeweler Style Forceps, Style 2, Straight, Strong Fine, 4¾" (12.1 cm)
- 160-404** Swiss Jeweler Style Forceps, Style 3, Straight, Narrow Fine Points, 4¾" (12.1 cm)
- 160-406** Swiss Jeweler Style Forceps, Style 4, Straight, Fine Points, 4¾" (11.2 cm)
- 160-408** Swiss Jeweler Style Forceps, Style 5, Straight, Super Fine Points, 4¾" (11.2 cm)
- 160-410** Swiss Jeweler Style Forceps, Style 6, Pickup, 4½" (11.4 cm)
- 160-412** Swiss Jeweler Style Forceps, Style 7, Curved, Fine Points, 4½" (11.4 cm)



740-100
740-105



740-103
740-108



740-130
740-132

MICRO SURGERY INSTRUMENTS

- | | |
|---------|---|
| 740-100 | Micro Surgery Scissors, Sharp/Sharp, Straight, Round Handle, 6" (15.2 cm) |
| 740-105 | Micro Surgery Scissors, Sharp/Sharp, Curved, Round Handle, 6" (15.2 cm) |
| 740-103 | Micro Surgery Scissors, Sharp/Sharp, Straight, Round Handle, 7" (17.8 cm) |
| 740-108 | Micro Surgery Scissors, Sharp/Sharp, Curved, Round Handle, 7" (17.8 cm) |
| 740-130 | Fallopian Tubal Forceps, 10 mm jaws, 7" (17.8 cm) |
| 740-132 | Fallopian Tubal Forceps, 12 mm jaws, 7" (17.8 cm) |



740-200
740-205



740-208
740-215



740-218
740-222



740-226
740-229

MICRO SURGERY INSTRUMENTS

- 740-200 Micro Surgery Needle Holder, Straight, Round Handles, Without Catch, 6" (15.2 cm)
- 740-205 Micro Surgery Needle Holder, Curved, Round Handles, Without Catch, 6" (15.2 cm)
- 740-208 Micro Surgery Needle Holder, Straight, Round Handles, With Catch, 6" (15.2 cm)
- 740-215 Micro Surgery Needle Holder, Curved, Round Handles, With Catch, 6" (15.2 cm)
- 740-218 Micro Surgery Needle Holder, Straight, Round Handles, Without Catch, 7" (17.8 cm)
- 740-222 Micro Surgery Needle Holder, Curved, Round Handles, Without Catch, 7" (17.8 cm)
- 740-226 Micro Surgery Needle Holder, Straight, Round Handles, With Catch, 7" (17.8 cm)
- 740-229 Micro Surgery Needle Holder, Curved, Round Handles, With Catch, 7" (17.8 cm)



162-305
162-307

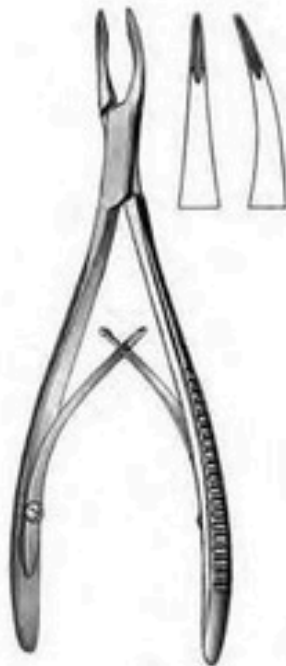

162-310
162-311



162-4451 62-4501 62-455



ENT INSTRUMENTS

- 162-305 LEMPERT Rongeur, Straight, Delicate, 2.5 mm Bite, 6 1/4" (15.9 cm), 765-810
- 162-307 LEMPERT Rongeur, Curved, Delicate, 2.5 mm Bite, 6 1/4" (15.9 cm), 765-815
- 162-310 Micro FRIEDMAN Rongeur, Straight 1.3 mm Wide Jaws, Very Delicate, 5 1/2" (14 cm), 804-135
- 162-311 Micro-FRIEDMAN Rongeur, Curved 1.3 mm Wide Jaws, Very Delicate, 5 1/2" (14 cm), 804-140
- 162-445 LUCAE Dressing Forceps, Bayonet Shape, Serrated tips, 5 1/2" (14 cm)
- 162-450 JANSEN Nasal Forceps, Bayonet Shape, 6 1/4" (15.9 cm)
- 162-455 JANSEN-GRUENWALD Nasal Forceps, Bayonet Shape, 8" (20.3 cm)



162-520
162-522
162-524



169-945

ENT INSTRUMENTS

- | | |
|----------------|--|
| 162-520 | HARTMAN Alligator Type Forceps, Serrated Jaws, 3½" (8.9 cm) |
| 162-522 | HARTMAN Alligator Type Forceps, Serrated Jaws, 5½" (14 cm) |
| 162-524 | HARTMAN Alligator Type Forceps, Serrated Jaws, 6½" (16.5 cm) |
| 169-945 | BEYER Rongeur, Double Action, Slightly Curved Jaws, 3.5 mm Wide, 7" (17.8 cm), 701-953 |

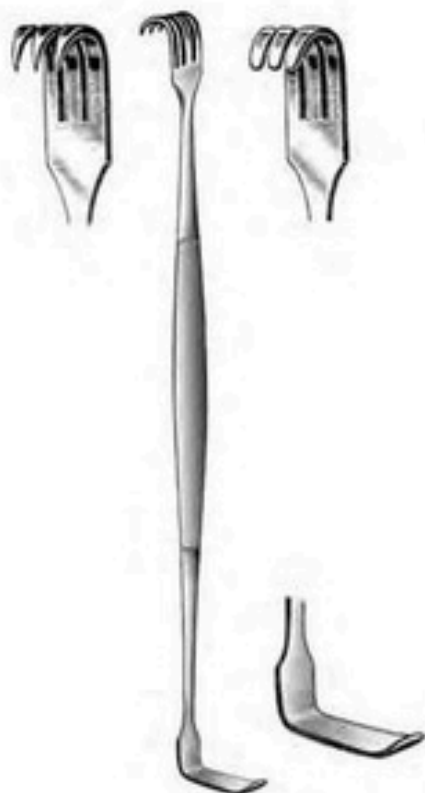

165-190
165-195



165-197

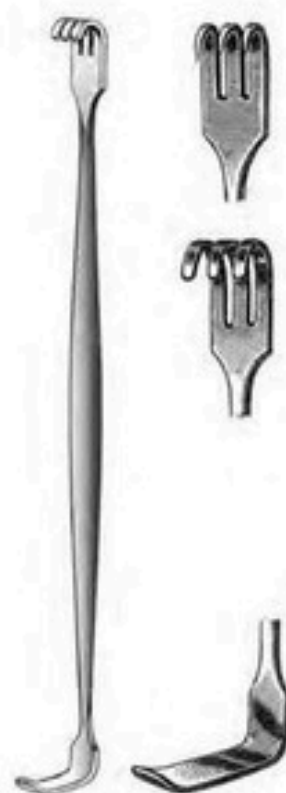

165-198
165-199

RETRACTORS

- | | | |
|---------|---|------------------|
| 165-190 | SENN Retractor, Double End, Three Sharp Pron | 1, 6½" (16.5 cm) |
| 165-195 | SENN Retractor, Double End, Three Blunt Pron | 1, 6½" (16.5 cm) |
| 165-197 | RAGNELL Retractor, Double End, Delicate, 6" | (15.2 cm) |
| 165-198 | MATHIEU Retractor, Double End, Three Sharp Pron | 1, 6½" (16.5 cm) |
| 165-199 | MATHIEU Retractor, Double End, Three Blunt Pron | 1, 6½" (16.5 cm) |

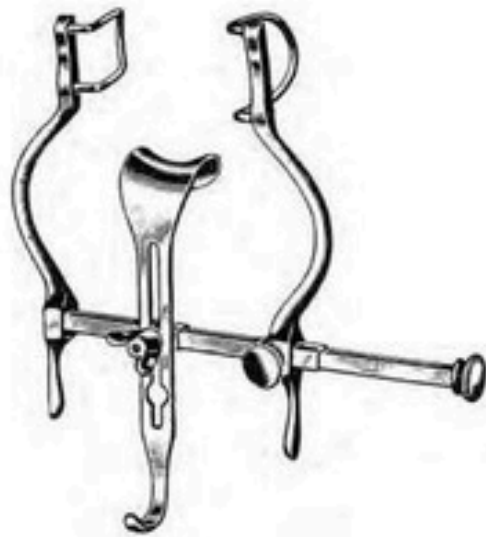

165-292



165-295



165-296



165-297



165-298



165-299

RETRACTORS

- 165-292 Pediatric BALFOUR Abdominal Retractor, 4" spread with Fenestrated Side Blades 4" (10.2 cm)
- 165-295 BALFOUR Center Blade For Retractor, Standard, 1 1/4" x 3" (4.5 x 7.6 cm) Deep
- 165-296 BALFOUR Center Blade For Retractor, Standard, 1 1/4" x 2 1/2" (4.5 x 6.7 cm) Deep
- 165-297 BALFOUR Center Blade For Retractor, Suprapubic, 2 1/4" x 3 1/4" (7 x 8.3 cm) Deep
- 165-298 BALFOUR Center Blade For Retractor, Extra deep model, 2 3/4" x 4" (7 x 10.2 cm) Deep
- 165-299 BALFOUR Center Blade For Retractor, Horgan Malleable, 2" x 5" (5.1 x 12.7 cm) Deep

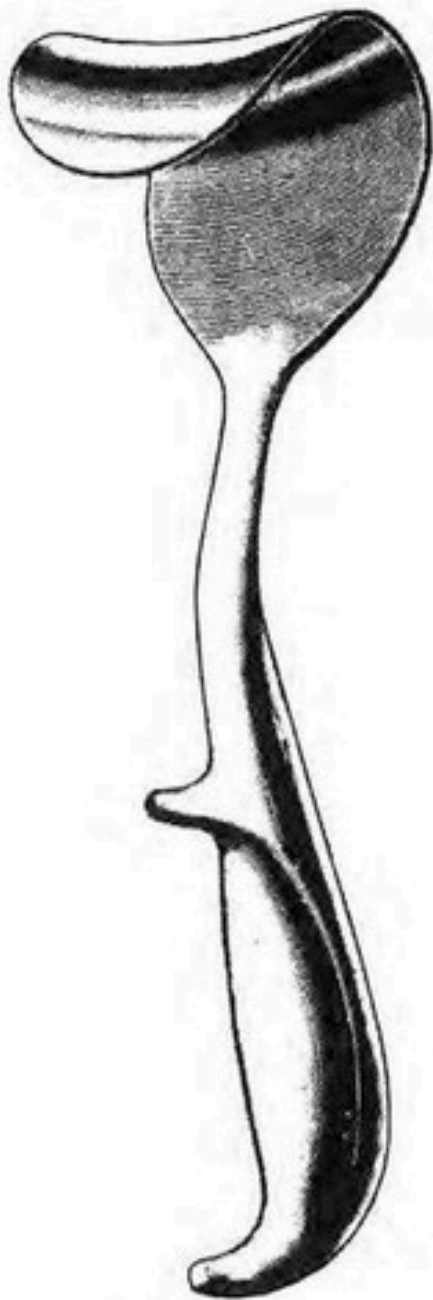

165-305

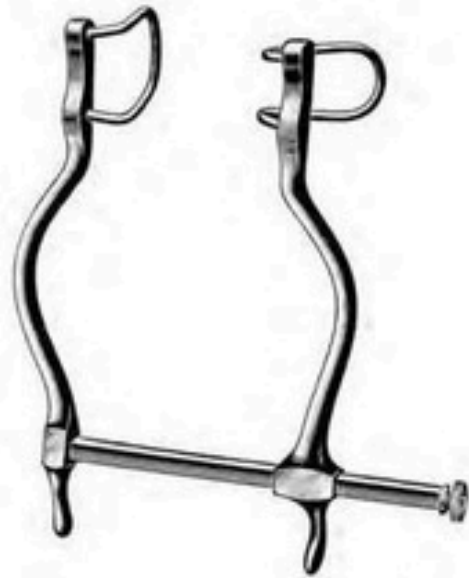

165-308
165-309

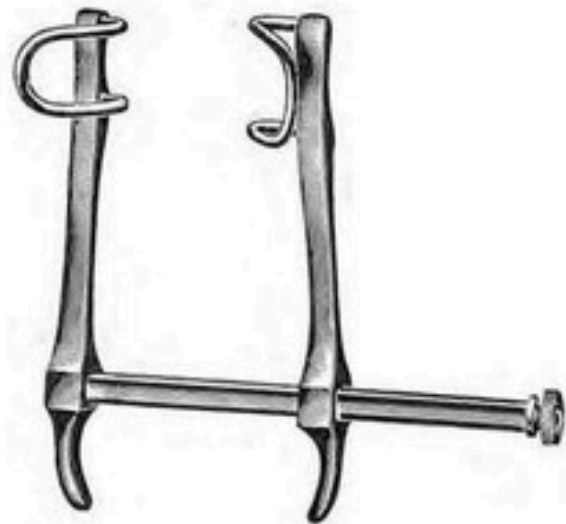

165-310

RETRACTORS

- 165-305 MAYO Abdominal Retractor, Blade $2\frac{3}{4}$ " (7 cm) Wide, 10" (25.4 cm)
- 165-308 GOSSET Retractor, 1" x $1\frac{1}{2}$ " (2.5 x 3.8 cm) Blades, 4" (10.2 cm) Spread
- 165-309 GOSSET Retractor, 1" x $2\frac{1}{2}$ " (2.5 x 6.4 cm) Blades, $5\frac{1}{2}$ " (14 cm) Spread
- 165-310 GOSSET Pediatric Retractor, $\frac{3}{4}$ " x 1" (2 x 2.5 cm) Blades, $3\frac{1}{2}$ " (8.9 cm) Spread

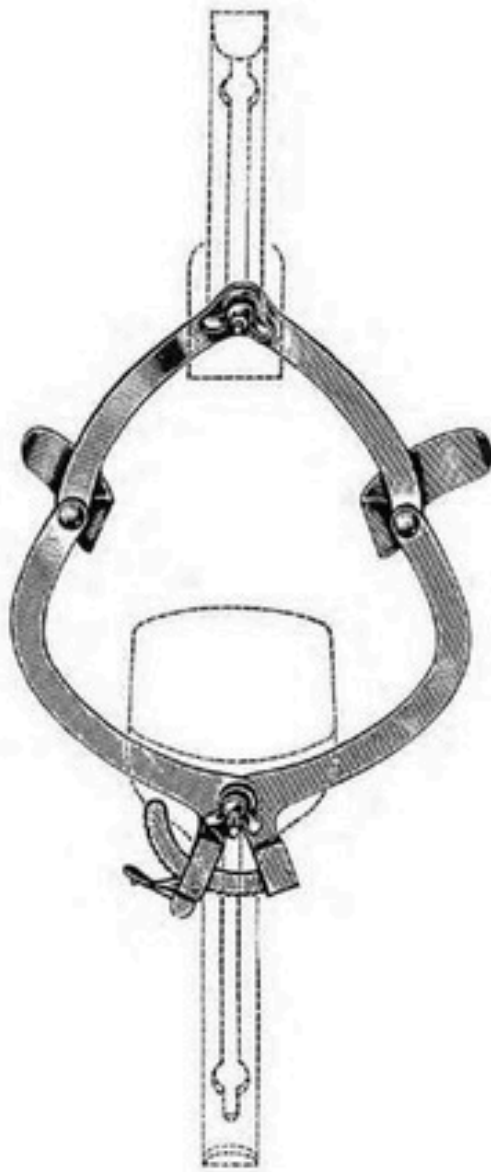

165-331



RETRACTORS

- 165-331** O'SULLIVAN-O'CONNOR Abdominal Retractor, with 3 Interchangeable Blades, two small size $1\frac{3}{4}'' \times 3\frac{1}{4}''$ (4.4 x 8.3 cm), one large size $2\frac{3}{4}'' \times 4\frac{1}{4}''$ (7 x 10.8 cm), 7" (17.8 cm)

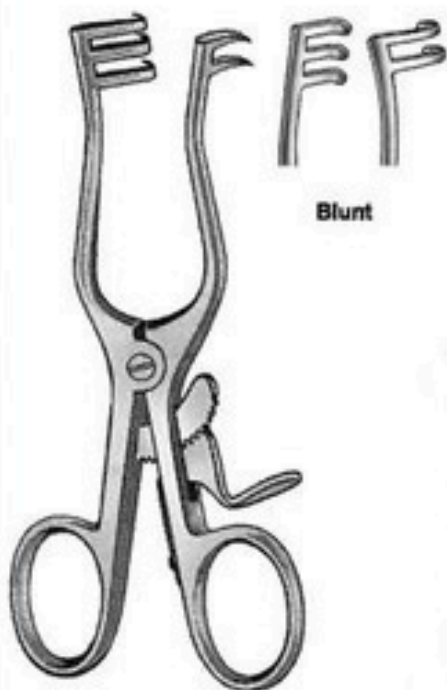

Blunt

165-332
165-334

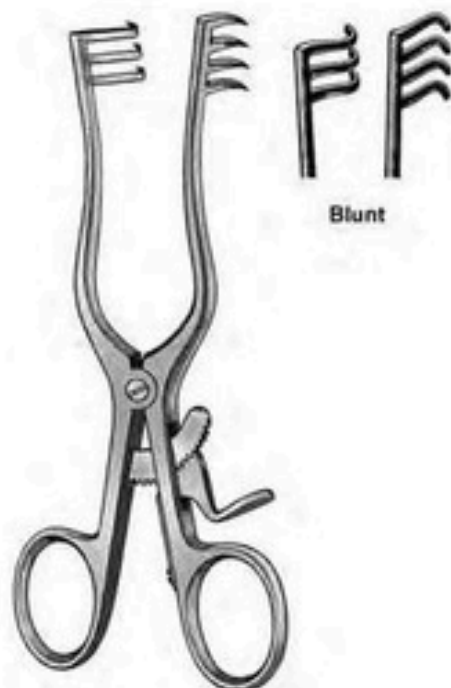

Blunt

165-336
to
165-354

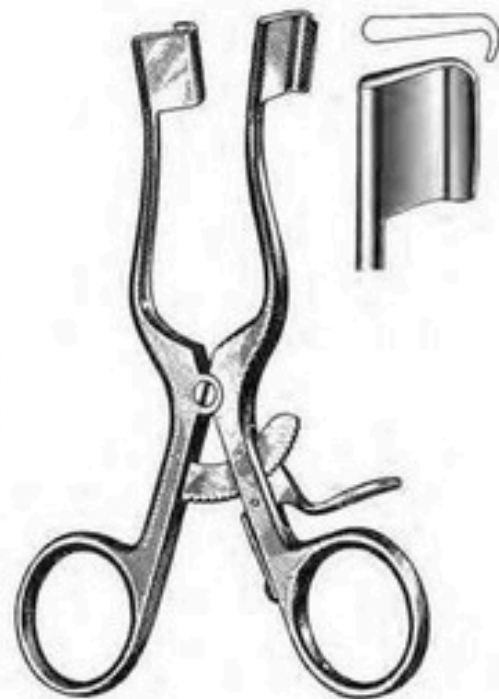

165-342

RETRACTORS

- 165-332 WEITLANER Retractor, Sharp, 2 x 3 Teeth, 4" (10.2 cm)
- 165-334 WEITLANER Retractor, Blunt, 2 x 3 Teeth, 4" (10.2 cm)

- 165-336 WEITLANER Retractor, Sharp, 3 x 4 Teeth, 5½" (14 cm)
- 165-338 WEITLANER Retractor, Blunt, 3 x 4 Teeth, 5½" (14 cm)
- 165-344 WEITLANER Retractor, Sharp, 3 x 4 Teeth, 6½" (16.5 cm)
- 165-346 WEITLANER Retractor, Blunt, 3 x 4 Teeth, 6½" (16.5 cm)
- 165-348 WEITLANER Retractor, Sharp, 3 x 4 Teeth, 8" (20.3 cm)
- 165-350 WEITLANER Retractor, Blunt, 3 x 4 Teeth, 8" (20.3 cm)
- 165-352 WEITLANER Retractor, Sharp, 3 x 4 Teeth, 9½" (24.1 cm)
- 165-354 WEITLANER Retractor, Blunt, 3 x 4 Teeth, 9½" (24.1 cm)

- 165-342 WEITLANER Retractor, Blunt Solid Blades, 5½" (14 cm)



165-355



165-356
165-360

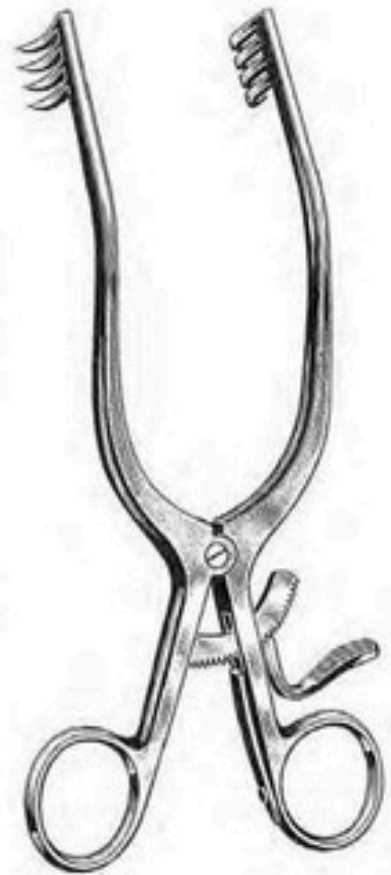
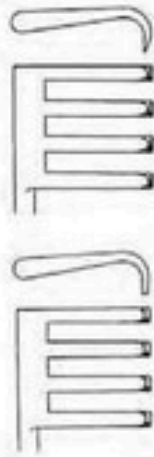

165-358

RETRACTORS

- 165-355 RIGBY Appendectomy Retractor, With Grip Lock, 6¾" (17.1 cm)
- 165-356 ADSON Retractor, Sharp, 4 x 4 Teeth, ¾" x ¾" (1.9 x 1.9 cm) Straight Arms, 7½" (19.1 cm)
- 165-360 ADSON Retractor, Blunt, 4 x 4 Teeth, ¾" x ¾" (1.9 x 1.9 cm) Straight Arms, 7½" (19.1 cm)
- 165-358 ADSON Retractor, Sharp, 4 x 4 Teeth, ¾" x ¾" (1.9 x 1.9 cm) Angled Arms, 7½" (19.1 cm)



165-362

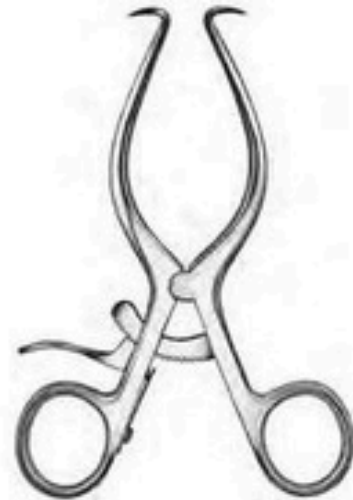

165-364



165-368



165-370
165-372

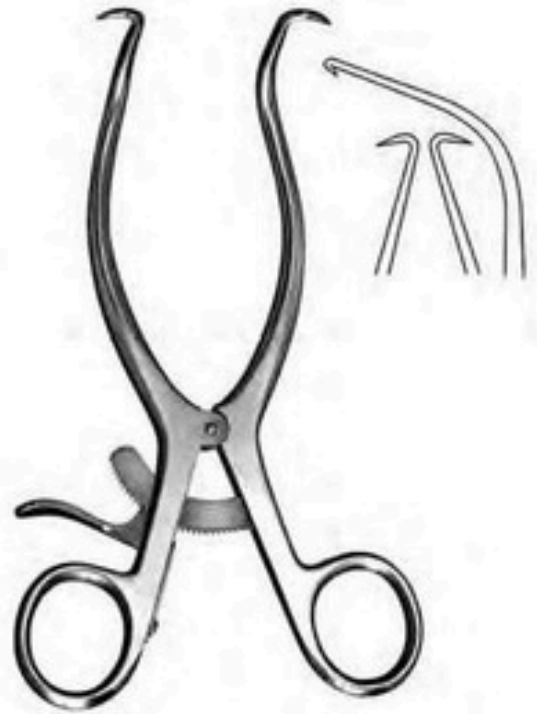

165-375

RETRACTORS

- 165-362 Mini GELPI Retractor, Pediatric, 3 1/2" (8.9 cm)
- 165-364 Baby GELPI Retractor, Pediatric, 4 1/2" (11.4 cm)
- 165-368 Baby GELPI Retractor, Pediatric, 5 1/2" (14 cm)
- 165-370 GELPI Retractor, With Grip Lock, 6 1/4" (17.1 cm)
- 165-372 GELPI Retractor, With Grip Lock, 7 1/2" (19.1 cm)
- 165-375 GELPI-SELETZ Retractor, Sharp Points, Deep Blades, 6 1/4" (15.9 cm)



SYSTEMS

of quality

GENERAL SURGICAL



165-378

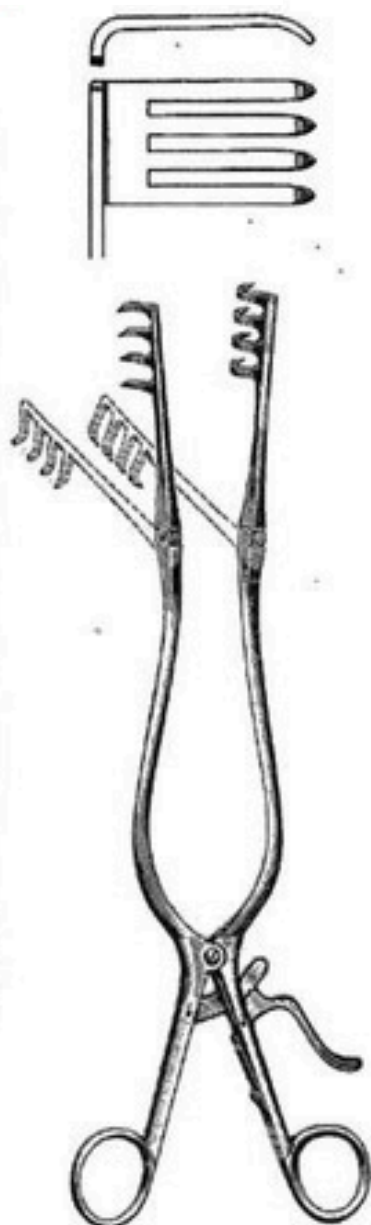

165-380
165-382

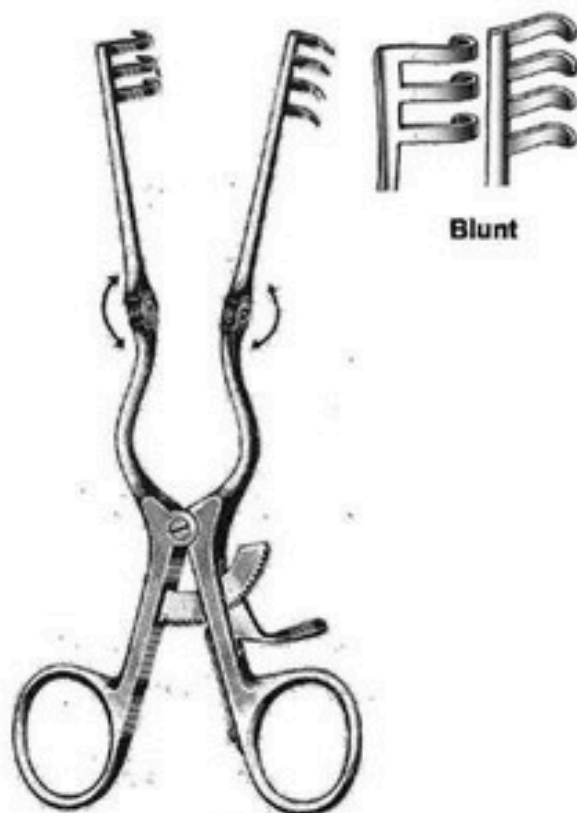

165-384
to
165-394

Blunt

RETRACTORS

- 165-378 WILTSE-GELPI Retractor, Sharp Points, Deep Blades, 11" (27.9 cm)
- 165-380 BECKMAN-ADSON Retractor, Hinge arms, Sharp Points, 4 x 4 teeth, 3/4" (1.9 cm) deep x 1" (2.5 cm) wide, 12" (30.5 cm)
- 165-382 BECKMAN-ADSON Retractor, Hinged, Sharp Points, 4 x 4 teeth, 1 1/4" (4.4 cm) deep x 1 1/4" (3.1 cm) wide, 12" (30.5 cm)
- 165-384 BECKMAN-WEITLANER Retractor, Hinged, Sharp Points, 3 x 4 Teeth, 5 1/2" (14 cm)
- 165-386 BECKMAN-WEITLANER Retractor, Hinged, Blunt Points, 3 x 4 Teeth, 5 1/2" (14 cm)
- 165-388 BECKMAN-WEITLANER Retractor, Hinged, Sharp Points, 3 x 4 Teeth, 6 1/2" (16.5 cm)
- 165-390 BECKMAN-WEITLANER Retractor, Hinged, Blunt Points, 3 x 4 Teeth, 6 1/2" (16.5 cm)
- 165-392 BECKMAN-WEITLANER Retractor, Hinged, Sharp Points, 3 x 4 Teeth, 9" (22.9 cm)
- 165-394 BECKMAN-WEITLANER Retractor, Hinged, Blunt Points, 3 x 4 Teeth, 9" (22.9 cm)



169-643

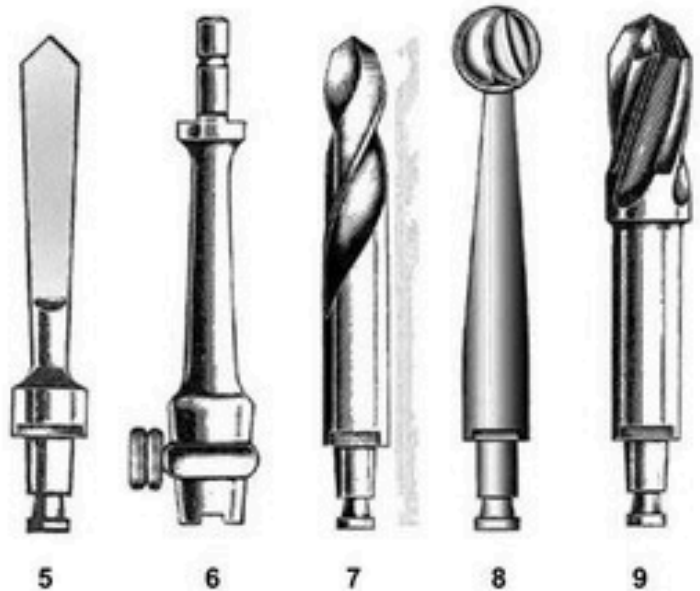

NEUROSURGICAL INSTRUMENTS

- 169-643** HUDSON Brace, With improved snap-lock chuck, 11" (27.9 cm)
(1 each 169-644 to 169-648)
- 169-644** CUSHING Perforator Drill, 1/2" (1.3 cm) diameter, Fig. 5
- 169-645** HUDSON Cerebellar Extension, 4" (10.2 cm), for use with Hudson braces, Fig. 6
- 169-646** MCKENZIE Perforator Drill, 13 mm diameter, Fig. 7
- 169-647** MCKENZIE Enlarging Bur Drill, 16 mm diameter, Fig. 8
- 169-648** D'ERRICO Perforator and Enlarging Bur, 16 mm diameter above burs, Fig. 9
Drills will fit Hudson Braces.



SYSTEMS

of quality

GENERAL SURGICAL

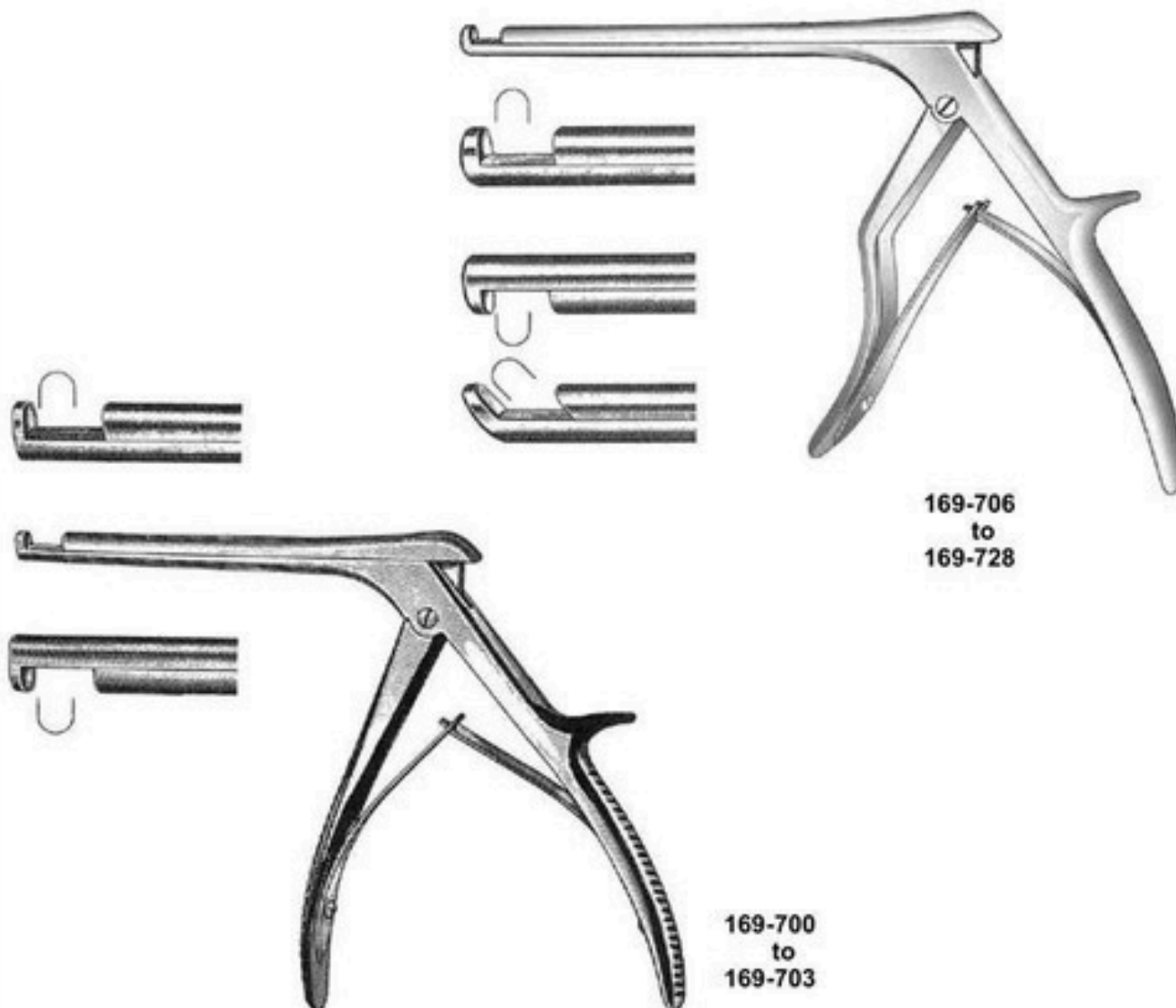

169-706
to
169-728

169-700
to
169-703

NEUROSURGICAL INSTRUMENTS

- 169-700 SCHLESINGER Cervical Rongeur, Thin Tip 3 mm Up-Bite, 6" (15.2 cm) Shaft, 720- 005
- 169-701 SCHLESINGER Cervical Rongeur, Thin Tip 5 mm Up-Bite, 6" (15.2 cm) Shaft, 720- 007
- 169-702 SCHLESINGER Cervical Rongeur, Thin Tip 3 mm Down-Bite, 6" (15.2 cm), Shaft 720- 009
- 169-703 SCHLESINGER Cervical Rongeur, Thin Tip 5 mm Down-Bite, 6" (15.2 cm), Shaft 720- 010

- 169-706 SPURLING-KERRISON Rongeur, 3 mm Up-Bite, 6" (15.2 cm) Shaft, 720- 018
- 169-708 SPURLING-KERRISON Rongeur, 5 mm Up-Bite, 6" (15.2 cm) Shaft, 720- 020
- 169-710 SPURLING-KERRISON Rongeur, 3 mm Down-Bite, 6" (15.2 cm) Shaft, 720- 021
- 169-712 SPURLING-KERRISON Rongeur, 5 mm Down-Bite, 6" (15.2 cm) Shaft, 720- 022
- 169-714 SPURLING-KERRISON Rongeur, 3 mm Bite, 40° Forward Angle, 6" (15.2 cm) Shaft, 720- 023
- 169-716 SPURLING-KERRISON Rongeur, 5 mm Bite, 40° Forward Angle, 6" (15.2 cm) Shaft, 720- 024

- 169-718 SPURLING-KERRISON Rongeur, 3 mm Up-Bite, 8" (20.3 cm) Shaft, 720- 025
- 169-720 SPURLING-KERRISON Rongeur, 5 mm Up-Bite, 8" (20.3 cm) Shaft, 720- 026
- 169-722 SPURLING-KERRISON Rongeur, 3 mm Down-Bite, 8" (20.3 cm) Shaft, 720- 028
- 169-724 SPURLING-KERRISON Rongeur, 5 mm Down-Bite, 8" (20.3 cm) Shaft, 720- 029
- 169-726 SPURLING-KERRISON Rongeur, 3 mm Bite, 40° Forward Angle, 8" (20.3 cm) Shaft, 720- 030
- 169-728 SPURLING-KERRISON Rongeur, 5 mm Bite, 40° Forward Angle, 8" (20.3 cm) Shaft, 720- 032

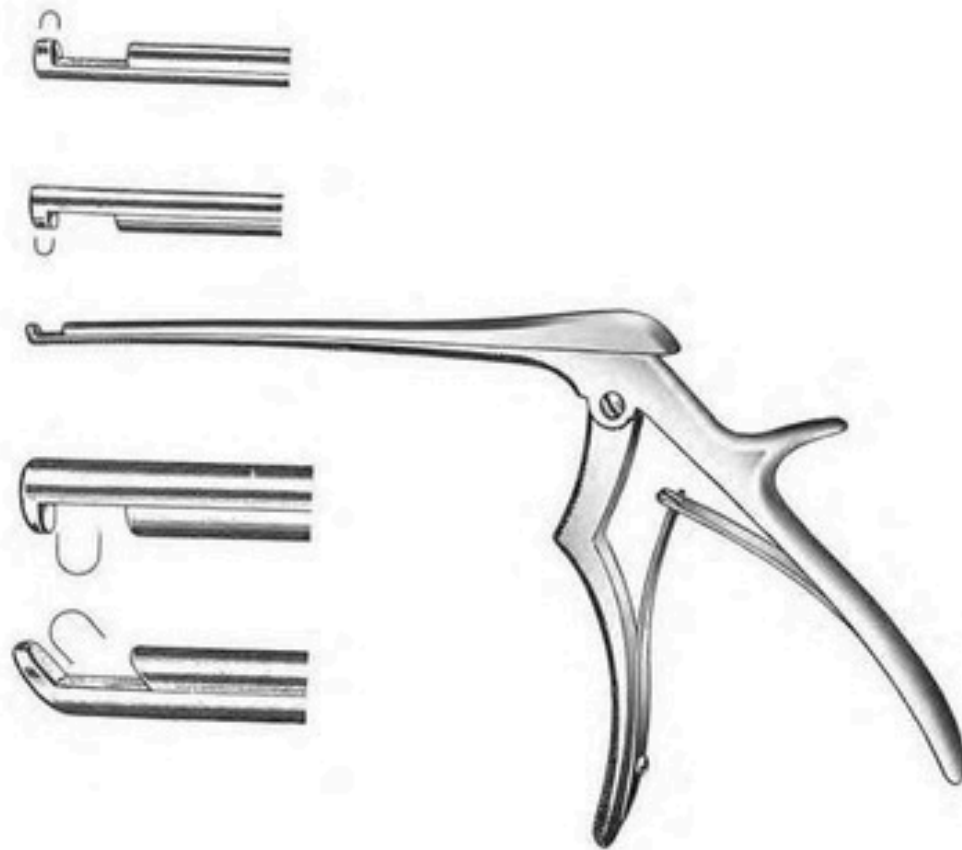

169-730
to
169-746

NEUROSURGICAL INSTRUMENTS

- 169-730 1KERRISON Cervical Rongeur, 2 mm Up-Bite, 7" (17.8 cm) Shaft, 720-043
- 169-732 1KERRISON Cervical Rongeur, 3 mm Up-Bite, 7" (17.8 cm) Shaft, 720-044
- 169-734 1KERRISON Cervical Rongeur, 5 mm Up-Bite, 7" (17.8 cm) Shaft, 720-045
- 169-736 1KERRISON Cervical Rongeur, 2 mm Down-Bite, 7" (17.8 cm) Shaft, 720-046
- 169-738 1KERRISON Cervical Rongeur, 3 mm Down-Bite, 7" (17.8 cm) Shaft, 720-047
- 169-740 1KERRISON Cervical Rongeur, 5 mm Down-Bite, 7" (17.8 cm) Shaft, 720-048
- 169-742 1KERRISON Cervical Rongeur, 2 mm 40° Forward-Bite, 7" (17.8 cm) Shaft, 720-049
- 169-744 1KERRISON Cervical Rongeur, 3 mm 40° Forward-Bite, 7" (17.8 cm) Shaft, 720-050
- 169-746 1KERRISON Cervical Rongeur, 5 mm 40° Forward-Bite, 7" (17.8 cm) Shaft, 720-051

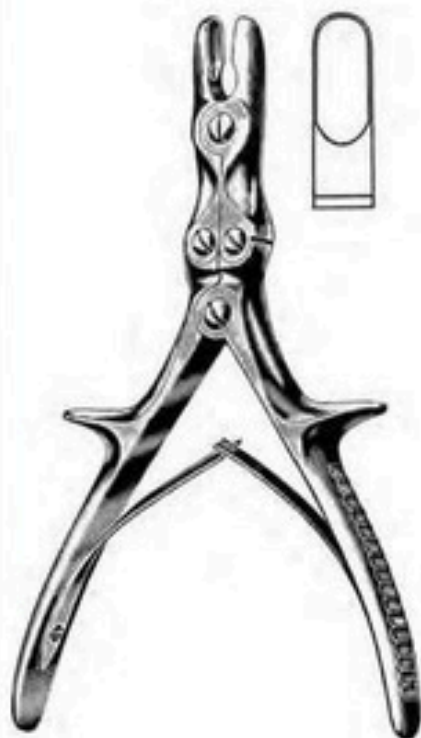

170-960



170-962

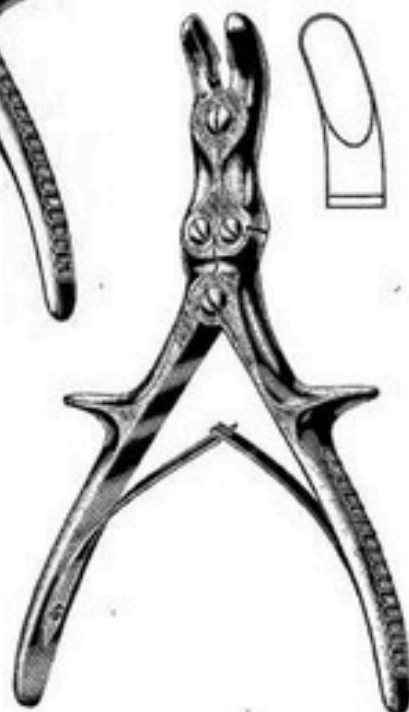

170-961



170-963
170-964

ORTHOPEDIC INSTRUMENTS

- 170-960 STILLE-LUER Rongeur, Straight, Jaws 9 x 15 mm, 8¾" (22.2 cm), 700-054
- 170-961 STILLE-LUER Rongeur, Curved, Jaws 9 x 15 mm, 8¾" (22.2 cm), 700-104
- 170-962 STILLE-LUER Duckbill Rongeur, Angled on Side, Jaws 6 x 12 mm, 9" (22.9 cm)
- 170-963 LEKSELL Laminectomy Rongeur, Curved, Jaws 3 mm Bite, 9½" (24.1 cm), 700-302
- 170-964 LEKSELL Laminectomy Rongeur, Curved, Jaws 8 mm Bite, 9½" (24.1 cm), 700-308



170-970



170-975



170-971
to
170-977

ORTHOPEDIC INSTRUMENTS

- | | |
|---------|--|
| 170-970 | RUSKIN Rongeur, Straight, Jaws 3 mm Bite, Double Action, 6" (15.2 cm), 701- 240 |
| 170-975 | RUSKIN Rongeur, Curved, Jaws 3 mm Bite, Double Action, 6" (15.2 cm), 701- 300 |
| 170-971 | RUSKIN Rongeur, Straight, Jaws 5 mm Bite, Double Action, 7¼" (18.4 cm), 701- 235 |
| 170-972 | RUSKIN Rongeur, Straight, Jaws 7 mm Bite, Double Action, 7¼" (18.4 cm), 701- 230 |
| 170-976 | RUSKIN Rongeur, Curved, Jaws 5 mm Bite, Double Action, 7¼" (18.4 cm), 701-250 |
| 170-977 | RUSKIN Rongeur, Curved, Jaws 7 mm Bite, Double Action, 7¼" (18.4 cm), 701-245 |



174-002



174-010
174-012



174-016



174-018
174-019

ORTHOPEDIC INSTRUMENTS

- 174-002** LUCAE Bone Mallet, Head 9 oz. (255 g), Satin Finish, 7 $\frac{3}{4}$ " (19.7 cm), 704-650
- 174-010** CRANE Mallet, Head 8 oz. (227 g), Chrome, 32 mm diam., Small, 6 $\frac{1}{2}$ " (16.5 cm), 704-675
- 174-012** CRANE Mallet, Head 16 oz. (454 g), Chrome, 38 mm diam., Large, 6 $\frac{1}{2}$ " (16.5 cm), 704-700
- 174-016** GERZOG Mallet, Head 8 oz. (227 g), Lead filled With Stainless Jacket, 7 $\frac{1}{2}$ " (19.1 cm), 704-858
- 174-018** Orthopedic Mallet, Head 16 oz. (454 g) Solid, Stainless, 11" (27.9 cm), 704-958
- 174-019** Orthopedic Mallet, Head 32 oz. (908 g) Solid, Stainless, 11" (27.9 cm), 704-959



176-600

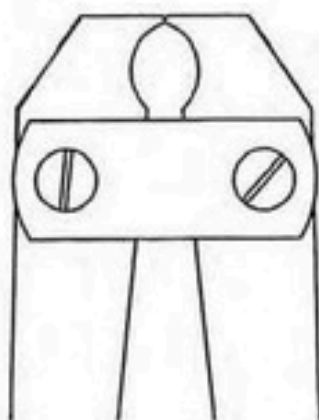
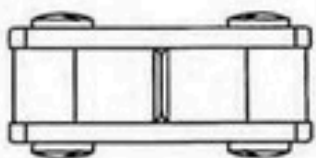

176-605

PIN AND ROD END CUTTERS
Cutter for Cutting of Kirschner Wires

176-600 Pin Cutter, Small, End cutting, Max. Cap. 3 mm, 10" (25.4 cm)

176-605 Pin Cutter, Medium, End cutting, Max. Cap. 4.7 mm, 16" (40.6 cm)

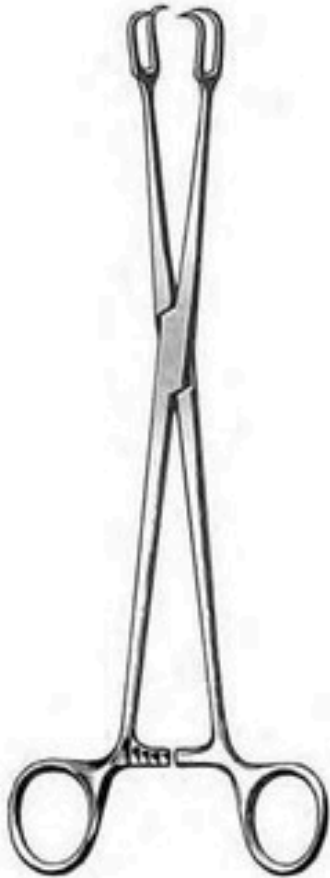

192-695

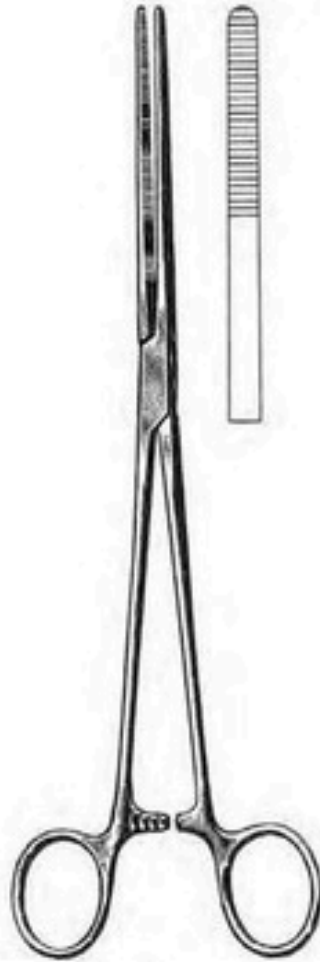

192-700



192-718

GYNECOLOGICAL INSTRUMENTS

- 192-695 SCHROEDER Vulsellum Forceps, Straight, 10" (25.4 cm)
- 192-700 BOZEMAN Uterine Dressing Forceps, Serrated, Straight, 10½" (26.7 cm)
- 192-718 BOZEMAN Uterine Dressing Forceps, Serrated, Double Curved, 10½" (26.7 cm)



192-750



192-752
192-754

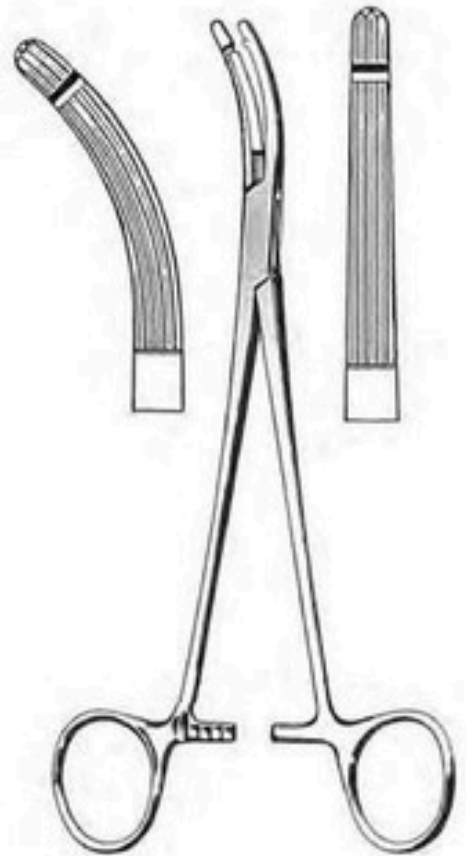

192-756
192-757

GYNECOLOGICAL INSTRUMENTS

- 192-750 HEANEY Hysterectomy Forceps, Heavy Pattern, Single Tooth, Curved, 8 1/4" (20.9 cm)
- 192-752 HEANEY Hysterectomy Forceps, Heavy Pattern, Double Tooth, Curved, 8 1/4" (20.9 cm)
- 192-754 HEANEY Hysterectomy Forceps, Extra Heavy Pattern, Double Tooth, Curved, 9 3/4" (24.8 cm)
- 192-756 BALLENTINE Hysterectomy Forceps, Single Tooth, Straight, 8 1/2" (21.6 cm)
- 192-757 HEANEY-BALLENTINE Hysterectomy Forceps, Single Tooth, Curved, 8 1/2" (21.6 cm)



192-772
192-773

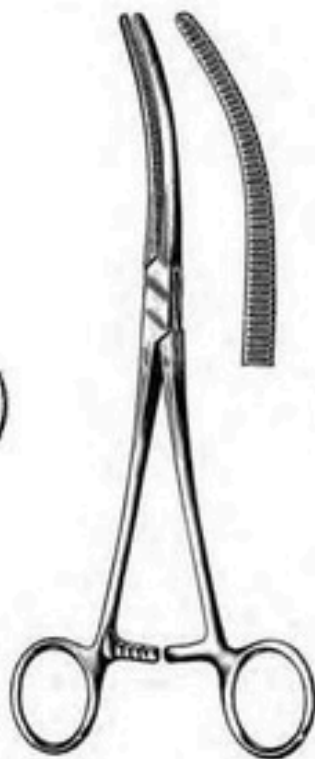

192-776
192-777



192-774
192-775
192-778
192-779



192-780

GYNECOLOGICAL INSTRUMENTS

- | | |
|---------|---|
| 192-772 | PEAN Hysterectomy Forceps, Straight, 8" (20.3 cm) |
| 192-773 | PEAN Hysterectomy Forceps, Straight, 9" (22.9 cm) |
| 192-774 | PEAN Hysterectomy Forceps, Straight, 10½" (26.7 cm) |
| 192-775 | PEAN Hysterectomy Forceps, Straight, 12" (30.5 cm) |
| 192-776 | PEAN Hysterectomy Forceps, Curved, 8" (20.3 cm) |
| 192-777 | PEAN Hysterectomy Forceps, Curved, 9" (22.9 cm) |
| 192-778 | PEAN Hysterectomy Forceps, Curved, 10¼" (26 cm) |
| 192-779 | PEAN Hysterectomy Forceps, Curved, 12" (30.5cm) |
| 192-780 | BIHRLE Dorsal Clamp, T.C. Inserts, Needle Holder, 11" (27.9 cm) |



192-798



192-800



192-845



192-860



192-865

GYNECOLOGICAL INSTRUMENTS

- 192-798 GRAVES Vaginal Speculum, Virgin Size, Narrow Blades, $\frac{3}{8}$ " x 3" (1 x 7.6 cm)
- 192-800 GRAVES Vaginal Speculum, Small, $\frac{3}{4}$ " x 3" (2 x 7.6 cm)
- 192-845 GRAVES Vaginal Speculum, Medium, $1\frac{1}{8}$ " x 4" (3.5 x 10.2 cm)
- 192-860 GRAVES Vaginal Speculum, Large, $1\frac{1}{2}$ " x $4\frac{1}{2}$ " (3.8 x 11.4 cm)
- 192-865 GRAVES Vaginal Speculum, Extra Large Blades, $1\frac{1}{2}$ " x $6\frac{3}{4}$ " (3.8 x 17.1 cm)



192-870



192-872



192-873



192-875



192-880

GYNECOLOGICAL INSTRUMENTS

- 192-870 MOORE-GRAVES Vaginal Speculum, 1½" x 3¼" (3.8 x 8.3 cm)
- 192-872 GUTTMAN Vaginal Speculum, (Examining Type) Solid Center Blade, 1½" x 4" (3.5 cm x 10.2 cm)
- 192-873 GUTTMAN Vaginal Speculum, (Operating Model) Fenestrated Center Blade, 1½" x 4" (4.4 x 10.2 cm)
- 192-875 GRAVES Vaginal Speculum, Open Right Side, Wide Angle Blades, Medium, 1½" x 4" (3.5 x 10.2 cm)
- 192-880 GRAVES Improved Vaginal Speculum, Wide Angle Blades, Medium, 1½" x 4" (3.5 x 10.2 cm)



192-898



192-900



192-910



192-915



192-920

GYNECOLOGICAL INSTRUMENTS

- 192-898** PEDERSON Vaginal Speculum, Virgin Size, Gold Screw, $\frac{3}{8}$ " x $2\frac{3}{4}$ " (1 x 7 cm), Extra Thin Blades
- 192-900** PEDERSON Vaginal Speculum, Small, Gold Screw, Narrow Blades, $\frac{1}{2}$ " x 3" (1.3 x 7.6 cm)
- 192-910** PEDERSON Vaginal Speculum, Medium, Gold Screw, Narrow Blades, $\frac{7}{8}$ " x 4" (2.2 x 10.2 cm)
- 192-915** PEDERSON Vaginal Speculum, Large, Gold Screw, Narrow Blades, 1" x $4\frac{3}{4}$ " (2.5 x 12.1 cm)
- 192-920** PEDERSON Vaginal Speculum, Extra Narrow Blades, Gold Screw, $\frac{5}{8}$ " x 4" (1.6 x 10.2 cm)



SYSTEMS

of quality

GENERAL SURGICAL

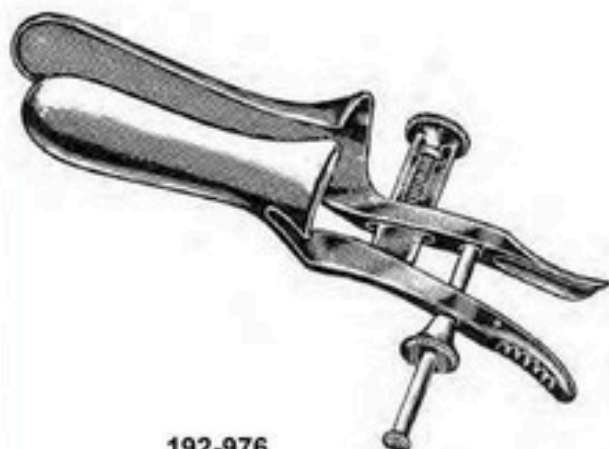

192-976
192-977
192-978

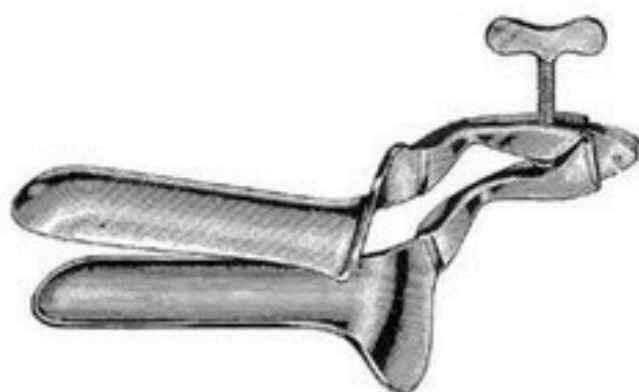

192-980
192-982
192-984

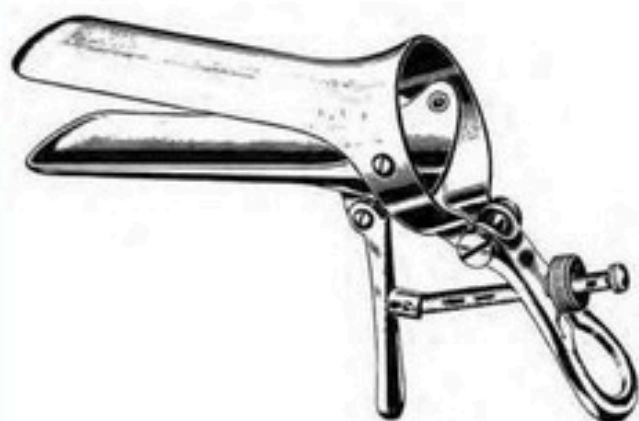

192-986
192-988
192-990



192-992
192-994
192-996

GYNECOLOGICAL INSTRUMENTS

- | | |
|---------|--|
| 192-976 | DEVILBISS Vaginal Speculum, Small, 7/8" x 3 1/2" (2.2 x 8.9 cm) |
| 192-977 | DEVILBISS Vaginal Speculum, Medium, 1 1/4" x 4" (3.2 x 10.2 cm) |
| 192-978 | DEVILBISS Vaginal Speculum, Large, 1 3/8" x 5" (3.5 x 12.7 cm) |
| 192-980 | COLLIN Vaginal Speculum, Small, 1 1/4" x 3 3/4" (3.2 x 9.5 cm) |
| 192-982 | COLLIN Vaginal Speculum, Medium, 1 3/8" x 4" (3.5 x 10.2 cm) |
| 192-984 | COLLIN Vaginal Speculum, large, 1 5/8" x 4 1/2" (4.1 x 11.4 cm) |
| 192-986 | CUSCO Vaginal Speculum, W/Center Screw, Small, 1 1/4" x 3 1/2" (3.2 x 8.9 cm) |
| 192-988 | CUSCO Vaginal Speculum, W/Center Screw, Medium, 1 3/8" x 4" (3.5 x 10.2 cm) |
| 192-990 | CUSCO Vaginal Speculum, W/Center Screw, Large, 1 3/8" x 4 1/2" (3.5 x 11.4 cm) |
| 192-992 | CUSCO Vaginal Speculum, W/Side Screw, Small, 1 1/4" x 3 1/2" (3.2 x 8.9 cm) |
| 192-994 | CUSCO Vaginal Speculum, W/Side Screw, Medium, 1 3/8" x 4" (3.5 x 10.2 cm) |
| 192-996 | CUSCO Vaginal Speculum, W/Side Screw, Large, 1 3/8" x 4 1/2" (3.5 x 11.4 cm) |



194-811
194-812



194-813
194-815
194-815-A



194-816
194-817

GYNECOLOGICAL INSTRUMENTS

- 194-811 Lateral Vaginal Wall Retractor, With Ratchet (Closed Shanks), 1" x 2½" (2.5 x 6.4 cm) Blades, Gold plated handle, 10½" (26.7 cm)
- 194-812 Lateral Vaginal Wall Retractor, With Ratchet (Closed Shanks), 1" x 3" (2.5 x 7.6 cm) Blades, Gold plated handle, 10½" (26.7 cm)
- 194-813 Lateral Vaginal Wall Retractor, Open Shanks, ⅝" x 2½" (2.2 x 6.4 cm) Blades, Small, Gold plated handle, 7¾" (19.7 cm)
- 194-815 Lateral Vaginal Wall Retractor, Open Shanks, ⅝" x 3½" (2.2 x 8.9 cm) Blades, Medium, Gold plated handle, 7¾" (19.7 cm)
- 194-815-A Lateral Vaginal Wall Retractor, Open Shanks, ⅝" x 4½" (2.2 x 11.4 cm) Blades, Large, Gold plated handle, 7¾" (19.7 cm)
- 194-816 PEDERSON 4-Way Expander Speculum, Medium, With Smoke Tube, Gold Screw
- 194-817 PEDERSON 4-Way Expander Speculum, Large, With Smoke Tube, Gold Screw



194-863
to
194-867



194-868
to
194-873



194-880
194-885
132-890

GYNECOLOGICAL INSTRUMENTS

- 194-863 BREISKY Vaginal Retractor, Blade 100 mm x 18 mm, Satin
- 194-864 BREISKY Vaginal Retractor, Blade 100 mm x 25 mm, Satin
- 194-865 BREISKY Vaginal Retractor, Blade 100 mm x 30 mm, Satin
- 194-866 BREISKY Vaginal Retractor, Blade 100 mm x 35 mm, Satin
- 194-867 BREISKY Vaginal Retractor, Blade 100 mm x 38 mm, Satin
- 194-868 BREISKY Vaginal Retractor, Blade 120 mm x 30 mm, Satin
- 194-869 BREISKY Vaginal Retractor, Blade 130 mm x 35 mm, Satin
- 194-870 BREISKY Vaginal Retractor, Blade 140 mm x 35 mm, Satin
- 194-871 BREISKY Vaginal Retractor, Blade 150 mm x 35 mm, Satin
- 194-872 BREISKY Vaginal Retractor, Blade 160 mm x 35 mm, Satin
- 194-873 BREISKY Vaginal Retractor, Blade 170 mm x 25 mm, Satin
- 194-880 YEOMAN Biopsy Punch Forceps, With Basket, 3.5 x 10 mm Bite, 9" (22.9 cm)
- 194-885 YEOMAN Biopsy Punch Forceps, With Basket, 3.5 x 10 mm Bite, 13" (33 cm)
- 194-890 YEOMAN Biopsy Punch Forceps, With Basket, 3.5 x 10 mm Bite, 15" (38 cm)



194-950



194-951



194-952



194-955

GYNECOLOGICAL INSTRUMENTS

- 194-950 HEANEY Uterine Biopsy Curette, Serrated Loop, 9" (22.9 cm)
- 194-951 SIMS Uterine Biopsy Curette, Extra Small Sharp Loop, 2.5 x 5 mm Head, 10" (25.4 cm)
- 194-952 KEVORKIAN-YOUNGUE Biopsy Curette, With Basket, Size 3 x 12 mm, 12" (30.5 cm)
- 194-955 KEVORKIAN-YOUNGUE Biopsy Curette, Without Basket, Size 3 x 12 mm, 12" (30.5 cm)

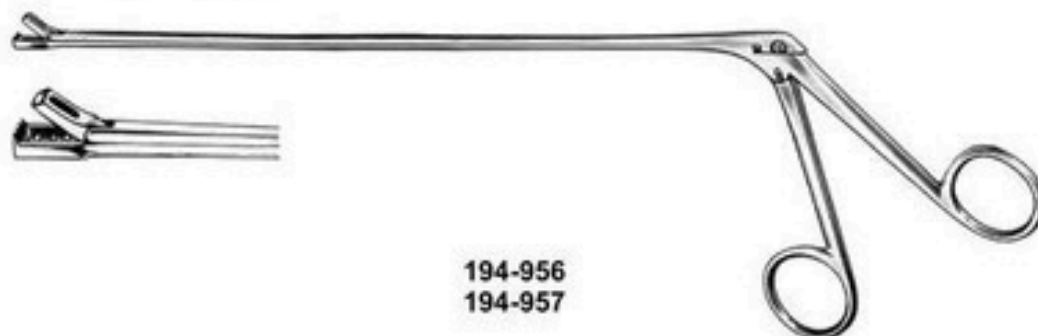

194-956
194-957



Straight

Angular

194-960
194-962

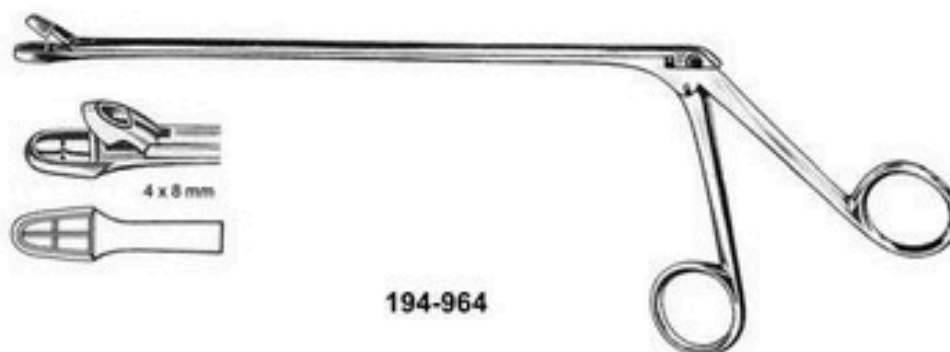

4 x 8 mm

194-964

GYNECOLOGICAL INSTRUMENTS

- 194-956 KEVORKIAN-YOUNGE Uterine Biopsy Forceps, 3.5 x 8 mm Bite, 9½" (24.1 cm)
194-957 KEVORKIAN-YOUNGE Uterine Biopsy Forceps, 3 x 10 mm Bite, 11" (27.9 cm)
194-960 WITTNER Biopsy Forceps, Straight Tip, With Teeth Lower Jaw, 8½" (21.6 cm)
194-962 WITTNER Biopsy Forceps, Angled tip, With Teeth Lower Jaw, 8½" (21.6 cm)
194-964 EPPENDORFER Uterine Biopsy Forceps, 4 x 8 mm Bite, 8½" (21.6 cm)

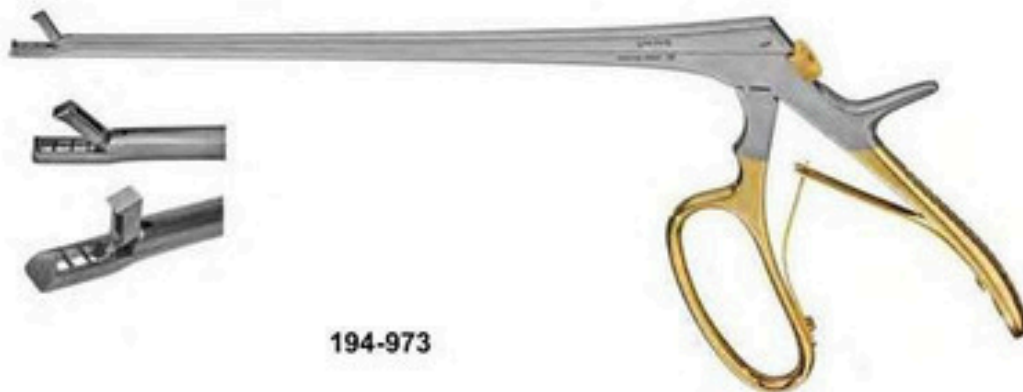

194-973

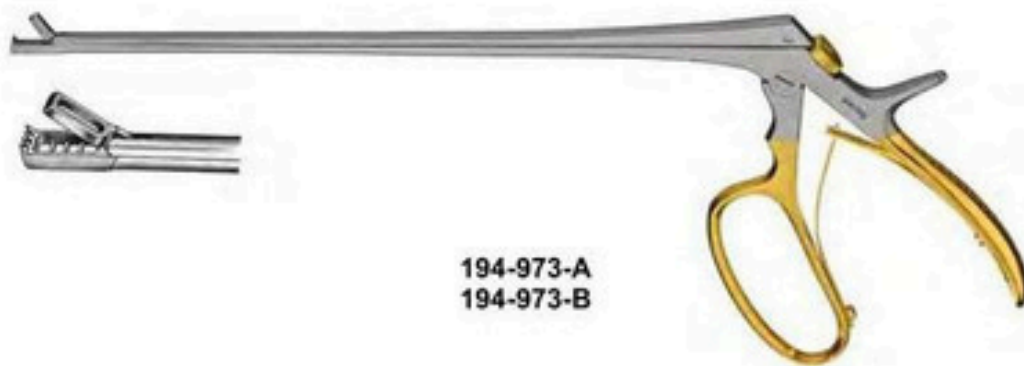

194-973-A
194-973-B

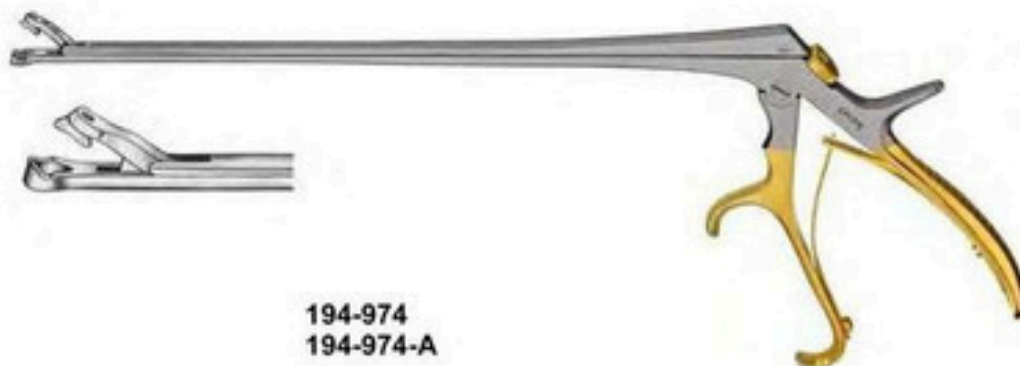

194-974
194-974-A

GYNECOLOGICAL INSTRUMENTS

- 194-973 KEVORKIAN Biopsy Forceps, 3 mm x 10 mm Bite, Spring Gold Plated Handle, With Locking Mechanism, 10" (25.4 cm)
- 194-973-A KEVORKIAN-PACIFIC Biopsy Forceps, 3 mm x 8 mm Bite, Spring Gold Plated Handle, With Locking Mechanism, 8½" (21.6 cm)
- 194-973-B KEVORKIAN-PACIFIC Biopsy Forceps, 3 mm x 8 mm Bite, Spring Gold Plated Handle, With Locking Mechanism, 10" (25.4 cm)
- 194-974 BURKE Biopsy Punch Forceps, 3 x 4.5 mm Bite, Spring Gold Plated Handle, With Locking Mechanism, 8" (20.3 cm)
- 194-974-A BURKE Biopsy Punch Forceps, 5 x 7 mm Bite, Spring Gold Plated Handle, With Locking Mechanism, 10" (25.4 cm)

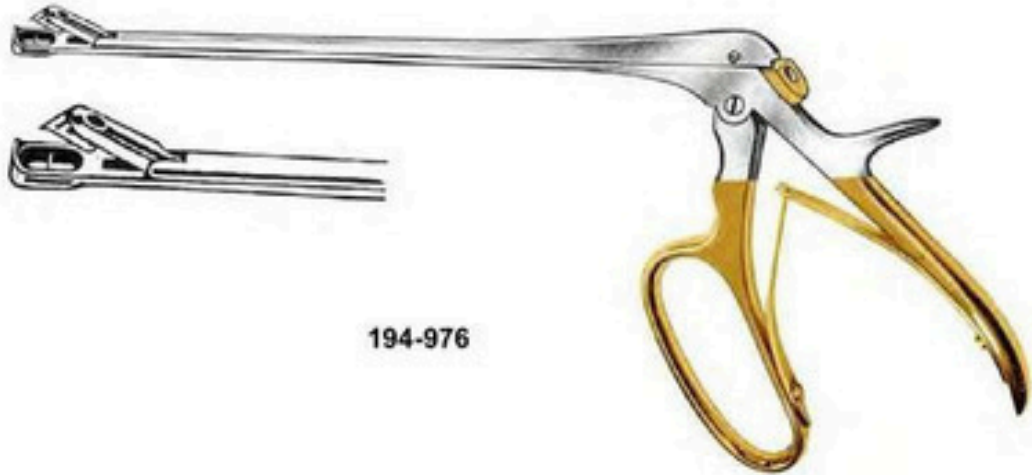

194-976

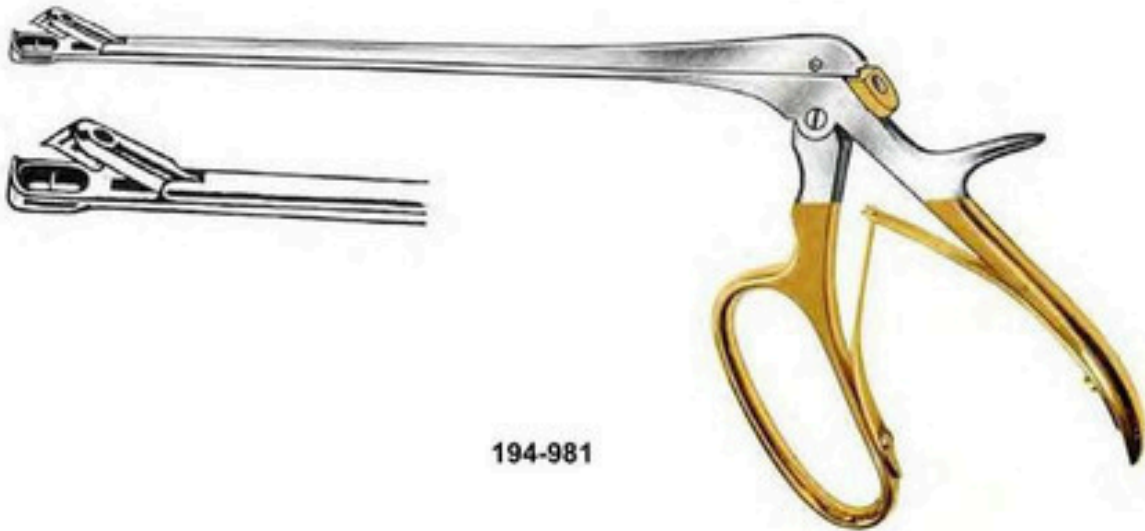

194-981

GYNECOLOGICAL INSTRUMENTS

- 194-976 TISCHLER-MORGAN Biopsy Forceps, 3 x 7 mm Bite, Spring Gold Plated Handle, With Locking mechanism, 9" (22.9 cm)
- 194-981 TISCHLER-MORGAN Biopsy Forceps, 3 x 7 mm Bite, Spring Gold Plated Handle, With Locking mechanism, Extra Long, 10" (25.4 cm)

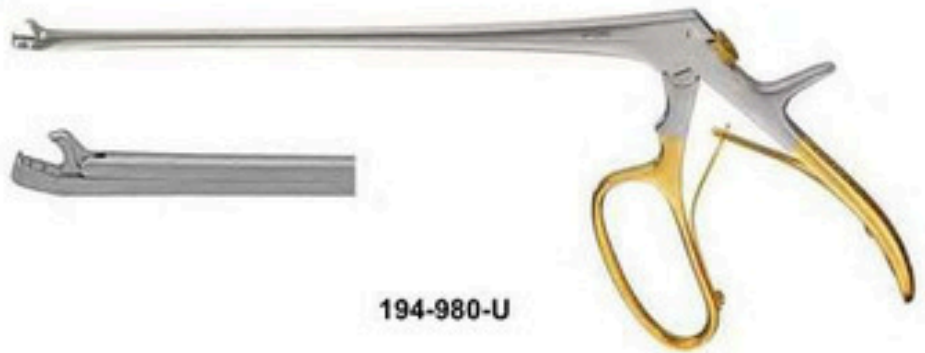

194-980-U



194-980-D



194-980-R

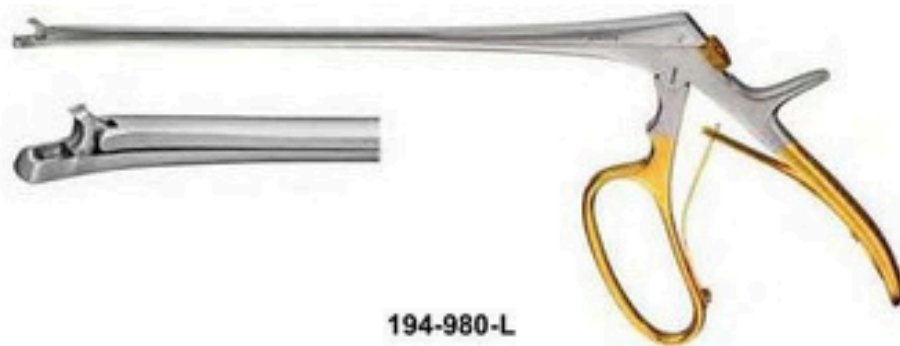

194-980-L

GYNECOLOGICAL INSTRUMENTS

- 194-980-U** Baby TISCHLER Biopsy Forceps, With Locking Mechanism, Spring Gold Plated Handle, 2.3 x 4.2 mm Up-Bite, 9" (22.9 cm)
- 194-980-D** Baby TISCHLER Biopsy Forceps, With Locking Mechanism, Spring Gold Plated Handle, 2.3 x 4.2 mm Down-Bite, 9" (22.9 cm)
- 194-980-R** Baby TISCHLER Biopsy Forceps, With Locking Mechanism, Spring Gold Plated, Handle, 2.3 x 4.2 mm Right-Bite, 9" (22.9 cm)
- 194-980-L** Baby TISCHLER Biopsy Forceps, With Locking Mechanism, Spring Gold Plated Handle, 2.3 x 4.2 mm Left-Bite, 9" (22.9 cm)



SYSTEMS

of quality

GENERAL SURGICAL

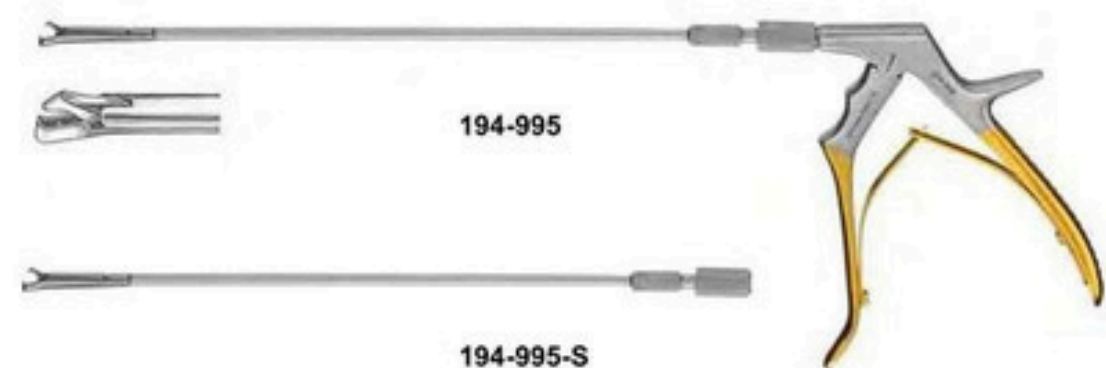
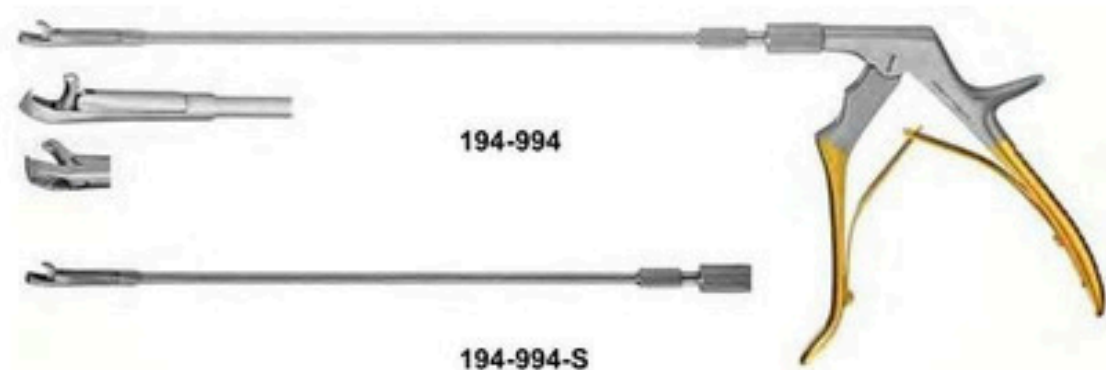
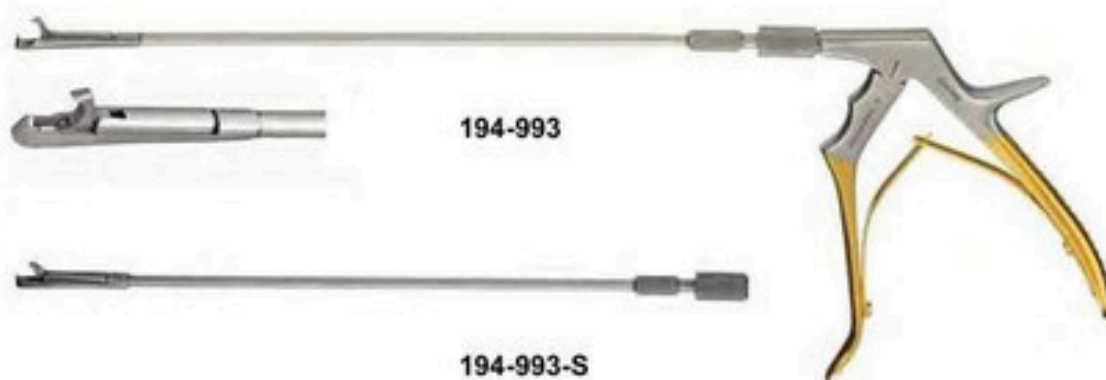

GYNECOLOGICAL INSTRUMENTS

- 194-993** TOWSEND Mini-Bite Biopsy Forceps, Complete, 2.3 x 4.2 mm Bite, Spring Gold Plated Handle, Rotating Shaft, 10" (25.4 cm)
- 194-993-S** TOWSEND Roto-Fit Shaft Only, 2.3 x 4.2 mm Bite, 10" (25.4 cm)
- 194-994** TOWSEND Mini-Bite Biopsy Forceps, Complete, 2.3 x 4.2 mm Up-Bite, Spring Gold Plated Handle, Rotating Shaft, 10" (25.4 cm)
- 194-994-S** TOWSEND Roto-Fit Shaft only, 2.3 x 4.2 mm Up-Bite, 10" (25.4 cm)
- 194-995** TOWSEND Mini-Bite Biopsy Forceps, Complete, 2.3 x 4.2 mm Down-Bite, Spring Gold Plated Handle, Rotating Shaft, 10" (25.4 cm)
- 194-995-S** TOWSEND Roto-Fit Shaft Only, 2.3 x 4.2 mm Down-Bite, 10" (25.4 cm)

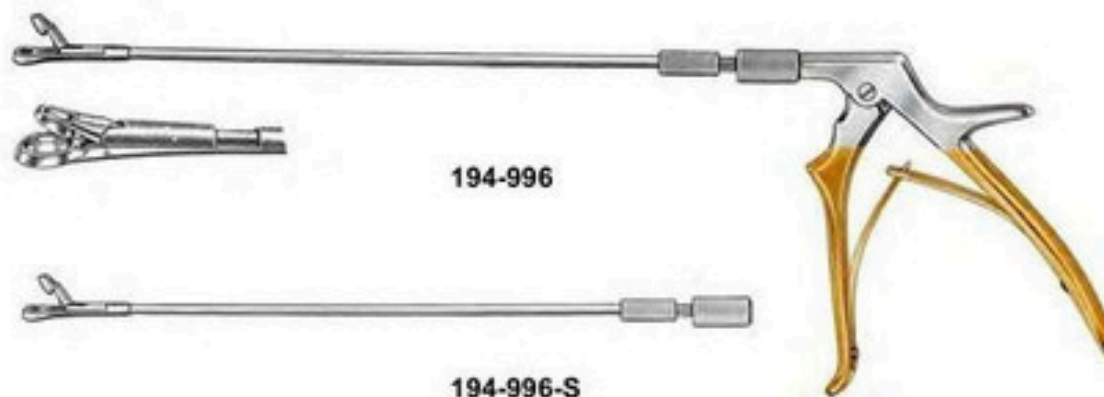
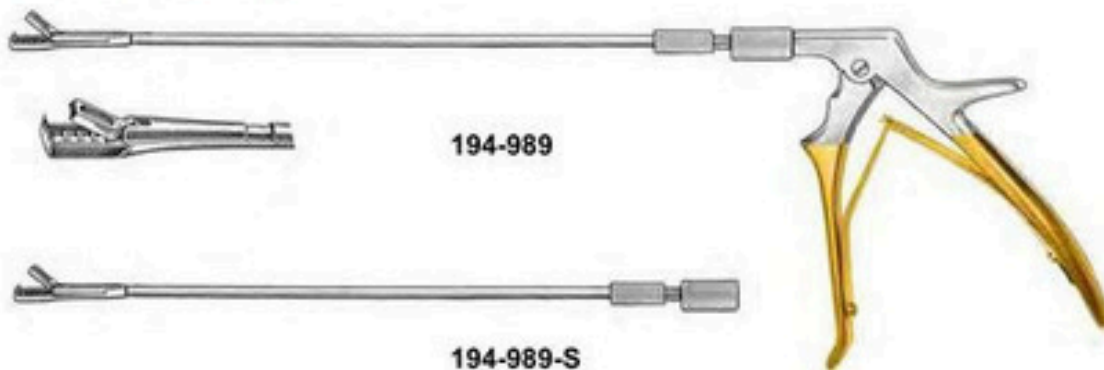

GYNECOLOGICAL INSTRUMENTS

- 194-989** KEVORKIAN-YOUNGE Biopsy Forceps, Complete, 3.5 x 8 mm Bite, Spring Gold Plated Handles, Rotating Shaft, 10" (25.4 cm)
- 194-989-S** KEVORKIAN Roto-Fit Shaft only, 10" (25.4 cm)
- 194-996** EPPENDORFER Biopsy Forceps, Complete, 4.5 x 6.5 mm Bite, Spring Gold Plated Handles, Rotating Shaft, 10" (25.4 cm)
- 194-996-S** EPPENDORFER Roto-Fit Shaft only, 10" (25.4 cm)
- 194-999** Roto-Fit Handle Only, for Rotating Shaft Uterine Biopsy Forceps, Gold Plated



195-658



195-660
195-661
195-662



195-667



195-707
195-756

DERMAL PODIATRY INSTRUMENTS

- 195-658** Nail Splitter, English Anvil Pattern, Double Spring, 5" (12.7 cm)
- 195-660** Nail Splitter, Straight Jaws, Extra Narrow, Double Spring, 5" (12.7 cm)
- 195-661** Nail Splitter, Straight Jaws, Extra Narrow, Double Spring, 5½" (14 cm)
- 195-662** Nail Splitter, Straight Jaws, Extra Narrow, Double Spring, 6" (15.2 cm)
- 195-667** Ingrown Nail Splitting Scissors, One Pointed Blade and One Serrated Blade, 6" (15.2 cm)
- 195-707** Nail Nipper, Concave Jaws, Barrel Spring, 4½" (11.4 cm)
- 195-756** Nail Nipper, Concave Jaws, Barrel Spring, 5½" (14 cm)



195-772



195-775

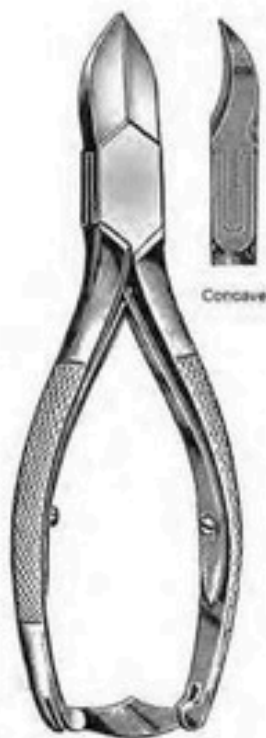

195-855
195-857
195-859



195-962



195-967

DERMAL PODIATRY INSTRUMENTS

- 195-772 Nail Nipper, Single Spring wire, Concave Jaws, 4½" (11.4 cm)
 195-775 Tissue and Cuticle Nipper, Convex Jaws, Single Spring, 4½" (11.4 cm)
 195-855 Nail Nipper, Double Spring, Concave Jaws, 5½" (14 cm)
 195-857 Nail Nipper, Double Spring, Concave Jaws, 6" (15.2 cm)
 195-859 Nail Nipper, Double Spring, Concave Jaws, 7" (17.8 cm)
 195-962 Nail Nipper, Double Spring, Angled Concave Jaws, 5½" (14 cm)
 195-967 Nail Nipper, Double Action, Sharp Concave Jaws, Barrel Spring, 6" (15.2 cm)



LARYNGOSCOPES STANDARD HANDLES AND BULBS

- 1061-798** Laryngoscope Handle, Small ("AA" Cell)
- 1061-800** Laryngoscope Handle, Medium ("C" Cell)
- 1061-805** Laryngoscope Handle, Large ("D" Cell)
- 1061-810** 2.5 Volt Bulb, Small (for Sizes MAC 00, 0, 1 and 2; MILLER 00, 0 and 1)
- 1061-815** 2.5 Volt Bulb, Large (for Sizes MAC 3, 4 and 5; MILLER 2, 3, 4 and 5)

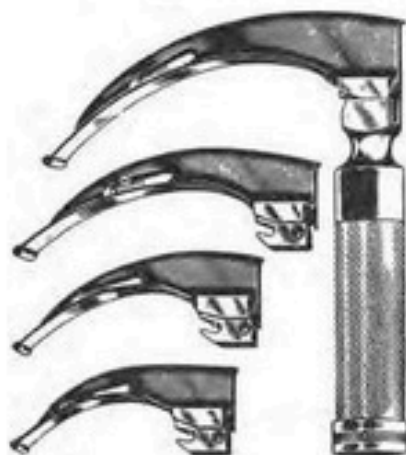

MACINTOSH STANDARD LARYNGOSCOPES

- 1061-807** MACINTOSH Baby Laryngoscope Set, Includes - 5 Blades 1 each of MAC No. 00, 0, 1, 2 and 3 and "C" Handle in Hard Case with 1 extra lamp
- 1061-808** MACINTOSH Infant Laryngoscope Set, Includes - 4 Blades 1 each of MAC No. 00, 0, 1 and 2 and "C" Handle in Hard Case with 1 extra lamp
- 1061-809** MACINTOSH Pediatric Laryngoscope Set, Includes - 4 Blades 1 each of MAC No. 0, 1, 2 and 3 and "C" Handle in Hard Case with 1 extra lamp
- 1061-811** MACINTOSH Laryngoscope Set, Includes - 4 Blades 1 each of MAC No. 1, 2, 3 and 4 and "C" Handle in Hard Case with 1 extra lamp
- 1061-813** MACINTOSH Laryngoscope Set, Includes - 5 Blades 1 each of MAC No. 0, 1, 2, 3 and 4 and "C" Handle in Hard Case with 1 extra lamp



1061-812
to
1061-817



1061-818
1061-818-A

MILLER AND MACINTOSH COMBINATION STANDARD LARYNGOSCOPES

- 1061-812** MILLER Baby Laryngoscope Set, Includes -5 Blades 1 Each of MILLER No.00, 0,1,2, and 3 and "C" Handle in Hard Case with 1 extra lamp
- 1061-814-A** MILLER Infant Laryngoscope Set, Includes - 4 Blades 1 Each of MILLER No.00, 0,1,and 2, and "C" Handle in Hard Case with 1 Extra Bulb
- 1061-814-B** MILLER Pediatric Laryngoscope Set, Includes - 4 Blades 1 Each of MILLER No.0, 1, 2, and 3, and "C" Handle in Hard Case with 1 Extra Bulb
- 1061-816** MILLER Laryngoscope Set, Includes - 4 Blades 1 Each of MILLER No.1, 2, 3, and 4, and "C" Handle in Hard Case with 1 Extra Bulb
- 1061-817** MILLER Laryngoscope Set, Includes - 5 Blades 1 Each of MILLER No.0, 1, 2, 3, and 4, and "C" Handle in Hard Case with 1 Extra Bulb
- 1061-818** MACINTOSH and MILLER Combination Laryngoscope Set, Includes - 8 Blades 1 Each of MAC No.1, 2, 3 and 4 and 1 Each of MILLER No.1, 2, 3 and 4 and "C" Handle in Hard Case with 2 Extra lamps
- 1061-818-A** MACINTOSH and MILLER Combination Laryngoscope Set, Includes - 10 Blades 1 Each of MAC No.0, 1, 2, 3 and 4, and 1 Each of MILLER No.0, 1, 2, 3 and 4 and "C" Handle in Hard Case with 2 Extra lamps



Hook-on Attachment



1061-819



1061-820



1061-825



1061-830



1061-835



1061-840



1061-841

MACINTOSH STANDARD LARYNGOSCOPE BLADES

- | | |
|-----------------|---|
| 1061-819 | MACINTOSH Standard Laryngoscope Blade, Stainless, Size 00, Small Premie |
| 1061-820 | MACINTOSH Standard Laryngoscope Blade, Stainless, Size 0, Premie |
| 1061-825 | MACINTOSH Standard Laryngoscope Blade, Stainless, Size 1, Infant |
| 1061-830 | MACINTOSH Standard Laryngoscope Blade, Stainless, Size 2, Child |
| 1061-835 | MACINTOSH Standard Laryngoscope Blade, Stainless, Size 3, Medium Adult |
| 1061-840 | MACINTOSH Standard Laryngoscope Blade, Stainless, Size 4, Large Adult |
| 1061-841 | MACINTOSH Standard Laryngoscope Blades Stainless, Size 5, Extra Large Adult |

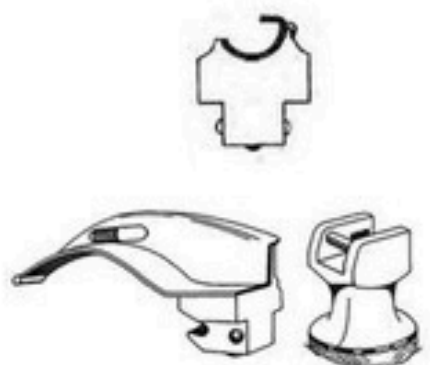

Hook-on Attachment



1061-844



1061-845



1061-850



1061-855



1061-860



1061-865



1061-866

MILLER STANDARD LARYNGOSCOPE BLADES

- | | |
|-----------------|---|
| 1061-844 | MILLER Standard Laryngoscope Blades, Stainless, Size 00 , Small Preemie |
| 1061-845 | MILLER Standard Laryngoscope Blades, Stainless, Size 0 , Preemie |
| 1061-850 | MILLER Standard Laryngoscope Blades, Stainless, Size 1 , Infant |
| 1061-855 | MILLER Standard Laryngoscope Blades, Stainless, Size 2 , Child |
| 1061-860 | MILLER Standard Laryngoscope Blades, Stainless, Size 3 , Medium Adult |
| 1061-865 | MILLER Standard Laryngoscope Blades, Stainless, Size 4 , Large Adult |
| 1061-866 | MILLER Standard Laryngoscope Blades, Stainless, Size 5 , Extra Large Adult |



1061-798-F/O



1061-800-F/O



1061-805-F/O



1061-810-F/O

LARYNGOSCOPES FIBER-OPTIC HANDLES AND BULBS

- | | |
|--------------|--|
| 1061-798-F/O | FIBER-OPTIC Laryngoscope Handle, Small ("AA" Cell) |
| 1061-800-F/O | FIBER-OPTIC Laryngoscope Handle, Medium ("C" Cell) |
| 1061-805-F/O | FIBER-OPTIC Laryngoscope Handle, Large ("D" Cell) |
| 1061-810-F/O | FIBER-OPTIC 2.5 Volt LED Lamp, Fits Handles Small, Medium, Large |



1061-807-FO



1061-808-FO

MACINTOSH FIBER-OPTIC LARYNGOSCOPES

- 1061-807-F/O** MACINTOSH FIBER-OPTIC Baby Laryngoscope Set, Includes - 5 Blades
1 Each No. 00, 0, 1, 2, and 3, and "C" Handle in Hard Case with 1 extra halogen lamp
- 1061-808-F/O** MACINTOSH FIBER-OPTIC Infant Laryngoscope Set, Includes - 4 Blades
1 Each No.00, 0, 1, and 2, and "C" Handle in Hard Case with 1 extra halogen lamp
- 1061-809-F/O** MACINTOSH FIBER-OPTIC Pediatric Laryngoscope Set, Includes - 4 Blades
1 Each No.0, 1, 2, and 3, and "C" Handle in Hard Case with 1 extra halogen lamp
- 1061-811-F/O** MACINTOSH FIBER-OPTIC Laryngoscope Set, Includes - 4 Blades
1 Each No.1, 2, 3 and 4 , and "C" Handle in Hard Case with 1 extra halogen lamp
- 1061-813-F/O** MACINTOSH FIBER-OPTIC Laryngoscope Set, Includes - 5 Blades
1 Each No. 0,1, 2, 3, and 4, and "C" Handle in Hard Case with 1 extra halogen lamp



**1061-812-FO
to
1061-817-F/O**



**1061-818-FO
to
1061-818-A-F/O**

MILLER AND MACINTOSH FIBER-OPTIC LARYNGOSCOPES

- 1061-812-F/O** MILLER FIBER-OPTIC Baby Laryngoscope Set, Includes - 5 Blades 1 Each No. 00, 0, 1, 2, and 3, and "C" Handle in Hard Case with 1 extra halogen lamp
- 1061-814-F/O** MILLER FIBER-OPTIC Infant Laryngoscope Set, Includes - 4 Blades 1 Each No. 00, 0, 1, and 2, and "C" Handle in Hard Case with 1 extra halogen lamp
- 1061-815-F/O** MILLER FIBER-OPTIC Pediatric Laryngoscope Set, Includes - 4 Blades 1 Each No. 0, 1, 2, and 3, and "C" Handle in Hard Case with 1 extra halogen lamp
- 1061-816-F/O** MILLER FIBER-OPTIC Laryngoscope Set, Includes - 4 Blades 1 Each No.1, 2, 3 and 4, and "C" Handle in Hard Case with 1 extra halogen lamp
- 1061-817-F/O** MILLER FIBER-OPTIC Laryngoscope Set, Includes - 5 Blades 1 Each No. 0, 1, 2, 3, and 4, and "C" Handle in Hard Case with 1 extra halogen lamp
- 1061-818-F/O** MACINTOSH and MILLER FIBER-OPTIC Combination Laryngoscope Set, Includes 8 Blades One Each of MAC No.0, 1, 2, and 3 , and MILLER No.0, 1, 2, and 3 and "C" Handle In Hard Case with 2 extra halogen lamp
- 1061-818-A-F/O** MACINTOSH and MILLER FIBER-OPTIC Combination Laryngoscope Set, Includes 10 Blades One Each of MAC No.0, 1, 2, 3 and 4, and MILLER No.0, 1, 2, 3 and 4 and "C" Handle In Hard Case with 2 extra halogen lamp

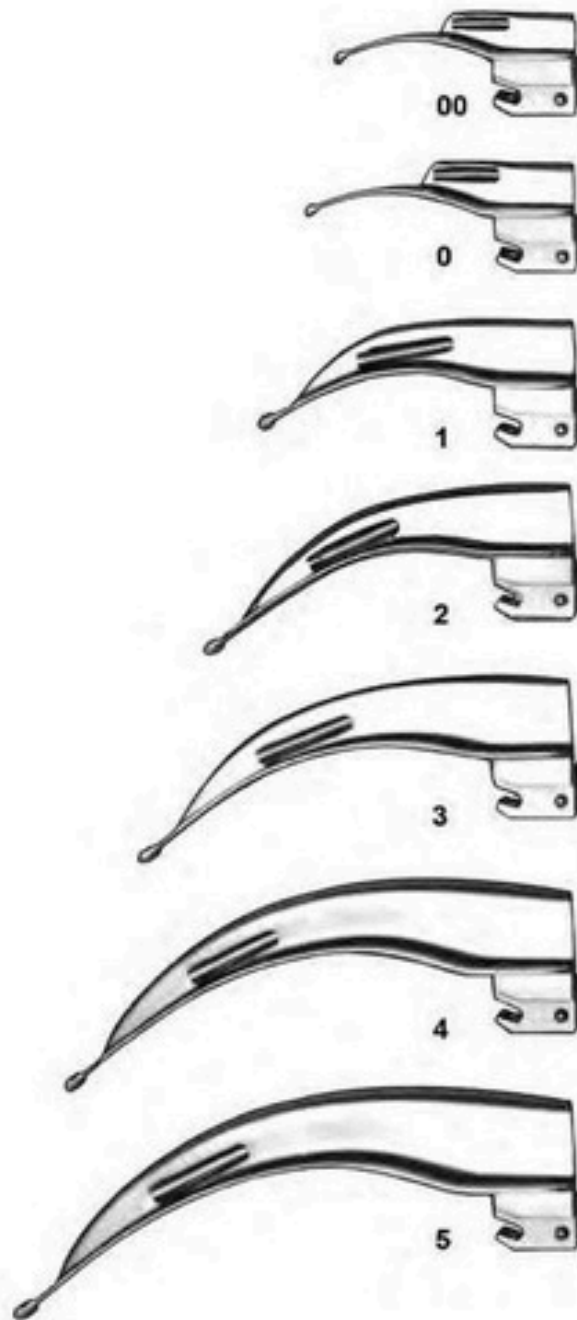

MACINTOSH FIBER-OPTIC LARYNGOSCOPE BLADES

- | | |
|--------------|--|
| 1061-819-F/O | MACINTOSH FIBER-OPTIC Laryngoscope Blade, Stainless, Size 00, Small Premie |
| 1061-820-F/O | MACINTOSH FIBER-OPTIC Laryngoscope Blade, Stainless, Size 0, Premie |
| 1061-825-F/O | MACINTOSH FIBER-OPTIC Laryngoscope Blade, Stainless, Size 1, Infant |
| 1061-830-F/O | MACINTOSH FIBER-OPTIC Laryngoscope Blade, Stainless, Size 2, Child |
| 1061-835-F/O | MACINTOSH FIBER-OPTIC Laryngoscope Blade, Stainless, Size 3, Medium Adult |
| 1061-840-F/O | MACINTOSH FIBER-OPTIC Laryngoscope Blade, Stainless, Size 4, Large Adult |
| 1061-841-F/O | MACINTOSH FIBER-OPTIC Laryngoscope Blade, Stainless, Size 5, Extra Large Adult |



MILLER FIBER-OPTIC LARYNGOSCOPE BLADES

- | | |
|--------------|---|
| 1061-844-F/O | MILLER FIBER-OPTIC Laryngoscope Blade, Stainless, Size 00, Small Premie |
| 1061-845-F/O | MILLER FIBER-OPTIC Laryngoscope Blade, Stainless, Size 0, Premie |
| 1061-850-F/O | MILLER FIBER-OPTIC Laryngoscope Blade, Stainless, Size 1, Infant |
| 1061-855-F/O | MILLER FIBER-OPTIC Laryngoscope Blade, Stainless, Size 2, Child |
| 1061-860-F/O | MILLER FIBER-OPTIC Laryngoscope Blade, Stainless, Size 3, Medium Adult |
| 1061-865-F/O | MILLER FIBER-OPTIC Laryngoscope Blade, Stainless, Size 4, Large Adult |
| 1061-866-F/O | MILLER FIBER-OPTIC Laryngoscope Blade, Stainless, Size 5, Extra Large Adult |



1061-870



1061-875



1061-880



1061-881

OTOSCOPES AND ENT DIAGNOSTIC SETS

- 1061-870** OTOSCOPE SET, Economy
OTOSCOPE Head W/Swivel Lens and 3 Aural Push-Fit Specula, (Small-Medium-Large) Which are Sterilizable, Autoclavable, Chrome Plated, Set Screw Lock Handle W/Rheostat. Houses 2 "C" Batteries (not included) Complete with 2 Replacement Lamps and Case
- 1061-875** Complete ENT Diagnostic Set
Complete Set for eyes, ears, nose and throat. Includes Battery handle, Ophthalmoscope head, Otoscope chamber, Reusable ear tips (sizes 2.5 mm, 3.5 mm and 4.5 mm), Nasal speculum screw type, Metal tongue depressor, Illuminated tongue holder, Laryngeal mirror #2, Laryngeal mirror #3, Tongue holder for wooden blades
- 1061-876** LED Bulbs - ENT Diagnostic set
- 1061-880** Pocket Fit Tongue Depressor, with two disposable plastic blades and soft pouch 2.5 volts standard illumination
- 1061-881** Disposable Tongue Depressor



1061-870-F/O



1061-871-F/O



1061-872

FIBER OPTIC OTOSCOPES

- 1061-870-F/O** Fiber Optic Oscope Set
Easy to use on/off system, with 2.5 volts halogen lamp
Ten disposable ear tips, two sizes 2.8 mm and 4 mm, packed in hard case
- 1061-871-F/O** Fiber Optic Mini Oscope Set, Pocket Fit
Easy to replace 2.5 volt halogen lamp.
Ten disposable ear tips, two sizes 2.8 mm and 4 mm.
Available in four colors, Black, Green, Blue and red in soft pouch
- 1061-872** Disposable ear tips pack of ten. Two sizes, 2.8 mm and 4 mm



110-738



110-740



110-742

LEEP INSTRUMENTS

- 110-738** LEEP GRAVES X-Large Speculum, With Smoke Evacuation Tube, 1 $\frac{3}{4}$ " x 6 $\frac{3}{4}$ " (3.5 x 17.1 cm)
- 110-740** LEEP GRAVES View-More Speculum, Medium, With Smoke Evacuation Tube, 1 $\frac{1}{4}$ " x 4" (3.2 x 10.2 cm), 4 cm Opening
- 110-742** LEEP GRAVES View-More Speculum, Large, With Smoke Evacuation Tube, 1 $\frac{3}{8}$ " x 4 $\frac{1}{2}$ " (3.5 x 11.4 cm), 4 cm Opening



110-744



110-745



110-748

LEEP INSTRUMENTS

- 110-744** LEEP GRAVES Maxi-View Speculum, With Smoke Evacuation Tube, Medium, 1¼" x 4" (3.2 x 10.2 cm), 7 cm Opening
- 110-745** LEEP GRAVES Maxi-View Speculum, With Smoke Evacuation Tube, Large, 1¾" x 4½" (3.5 x 11.4 cm), 7 cm Opening
- 110-748** LEEP MOORE-GRAVES Vaginal Speculum, With Smoke Evacuation Tube, 1½" x 3¼" (3.8 x 8.3 cm)



110-760
110-761
110-762



110-763
110-765



110-764
110-766

LEEP INSTRUMENTS

- 110-760 LEEP COLLIN Speculum, With Smoke Evacuation Tube, Small, 1¼" x 3¾" (3.2 x 9.5 cm)
- 110-761 LEEP COLLIN Speculum, With Smoke Evacuation Tube, Medium, 1½" x 4" (3.8 x 10.2 cm)
- 110-762 LEEP COLLIN Speculum, With Smoke Evacuation Tube, Large, 1¾" x 4½" (4.4 x 11.4 cm)

- 110-763 LEEP WEISMAN-GRAVES Left side Open Speculum, With Smoke Evacuation Tube, Medium, 1¼" x 4" (3.2 x 10.2 cm)
- 110-764 LEEP WEISMAN-GRAVES Right side Open Speculum, With Smoke Evacuation Tube, Medium, 1¼" x 4" (3.2 x 10.2 cm)

- 110-765 LEEP WEISMAN-GRAVES Left side Open Speculum, With Smoke Evacuation Tube, Large, 1¾" x 4½" (3.5 x 11.4 cm)
- 110-766 LEEP WEISMAN-GRAVES Right side Open Speculum, With Smoke Evacuation Tube, Large, 1¾" x 4½" (3.5 x 11.4 cm)



110-776
110-777
110-778

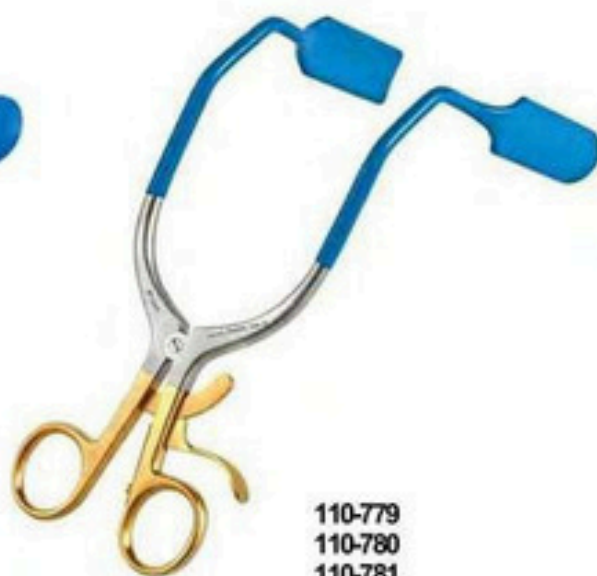

110-779
110-780
110-781



110-782
110-792

LEEP INSTRUMENTS

- 110-776 LEEP Lateral Wall Retractor, With Ratchet, Closed Shanks, 2½" (6.4 cm) Blades, 10" (25.4 cm)
- 110-777 LEEP Lateral Wall Retractor, With Ratchet, Closed Shanks, 3" (7.6 cm) Blades, 10" (25.4 cm)
- 110-778 LEEP Lateral Wall Retractor, With Ratchet, Closed Shanks, 4½" (11.4 cm) Blades, 10" (25.4 cm)
- 110-779 LEEP Lateral Wall Retractor, Open Shanks, 2½" (6.4 cm) Blades, 7¾" (19.7 cm)
- 110-780 LEEP Lateral Wall Retractor, Open Shanks, 3½" (8.9 cm) Blades, 7¾" (19.7 cm)
- 110-781 LEEP Lateral Wall Retractor, Open Shanks, 4½" (11.4 cm) Blades, 7¾" (19.7 cm)
- 110-782 LEEP Redundant Wall Retractor, (Rigby) Medium, ⅝" x 2½" (2.2 x 6.4 cm) Blades, 7¾" (19.7 cm)
- 110-792 LEEP Redundant Wall Retractor, (Rigby) Large, ⅝" x 3" (2.2 x 7.6 cm) Blades, 7¾" (19.7 cm)



110-796



110-797



110-798



110-799



110-799-A

LEEP INSTRUMENTS

- 110-796 LEEP SCHROEDER Tenaculum Forceps, With Exposed Tips, 10" (25.4 cm)
- 110-797 LEEP SCHROEDER Tenaculum Forceps, With Coated Tips, 10" (25.4 cm)
- 110-798 LEEP BRAUN Tenaculum Forceps, With Exposed Tips, 10" (25.4 cm)
- 110-799 LEEP BRAUN Tenaculum Forceps, With Coated Tips, 10" (25.4 cm)
- 110-799-A LEEP FOERSTER Ring Forceps, Serrated, With Coated Tips, 9½" (24.1 cm)

BARIATRIC SURGICAL INSTRUMENTS

GENERAL SURGICAL





1950-100



1950-110

BARIATRIC SURGICAL INSTRUMENTS

- 1950-100 MAYO Dissecting Scissors, Straight, T.C. Edges, 12" (30.5 cm)
- 1950-110 MAYO Dissecting Scissors, Curved, T.C. Edges, 12" (30.5 cm)



1950-155



1950-160



1950-170

BARIATRIC SURGICAL INSTRUMENTS

- 1950-155 RUSSIAN Tissue Forceps, 11" (27.9 cm)
- 1950-160 Thumb Dressing Forceps, 12" (30.5 cm)
- 1950-170 Thumb Tissue Forceps, 1 x 2 Teeth, 12" (30.5 cm)



1950-180



1950-190



1950-200



1950-210

BARIATRIC SURGICAL INSTRUMENTS

1950-180 ROCHESTER-PEAN Hemostatic Forceps, Straight, 12" (30.5 cm)

1950-190 ROCHESTER-PEAN Hemostatic Forceps, Curved, 12" (30.5 cm)

1950-200 ROCHESTER-OCHSNER Hemostatic Forceps, 1 x 2 Teeth, Straight, 12" (30.5 cm)

1950-210 ROCHESTER-OCHSNER Hemostatic Forceps, 1 x 2 Teeth, Curved, 12" (30.5 cm)



1950-220



1950-230



1950-240

BARIATRIC SURGICAL INSTRUMENTS

- 1950-220 GEMINI Forceps, Curved, 12" (30.5 cm)
- 1950-230 MAYO-HEGAR Needle Holder, T.C. Inlays, 12" (30.5 cm)
- 1950-240 CRILE-WOOD Needle Holder, T.C. Inlays, 12" (30.5 cm)



1950-250
1950-252



1950-260



1950-265

BARIATRIC SURGICAL INSTRUMENTS

- 1950-250 ALLIS Tissue Forceps, 4 x 5 Teeth, 12" (30.5 cm)
- 1950-252 ALLIS Tissue Forceps, 5 x 6 Teeth, 12" (30.5 cm)
- 1950-260 BABCOCK Intestinal Forceps, 12" (30.5 cm)
- 1950-265 RUSSIAN Tissue Forceps, 12" (30.5 cm)



1950-267



1950-270



1950-280



1950-290

BARIATRIC SURGICAL INSTRUMENTS

- | | |
|----------|---|
| 1950-267 | YANKAUER Suction Tube with Removable Tips, 14" (35.6 cm) |
| 1950-270 | MAYO Dissecting Scissors, Straight, T.C. Edges, 14" (35.6 cm) |
| 1950-280 | MAYO Dissecting Scissors, Curved, T.C. Edges, 14" (35.6 cm) |
| 1950-290 | METZENBAUM Scissors, Curved, T.C. Edges, 14" (35.6 cm) |



1950-300



1950-310



1950-320



1950-325

BARIATRIC SURGICAL INSTRUMENTS

- 1950-300 Thumb Dressing Forceps, 14" (35.6 cm)
- 1950-310 Thumb Tissue Forceps, 1 x 2 Teeth, 14" (35.6 cm)
- 1950-320 DeBAKEY Tissue Forceps, 14" (35.6 cm)
- 1950-325 RUSSIAN Tissue Forceps, 14" (35.6 cm)



1950-330

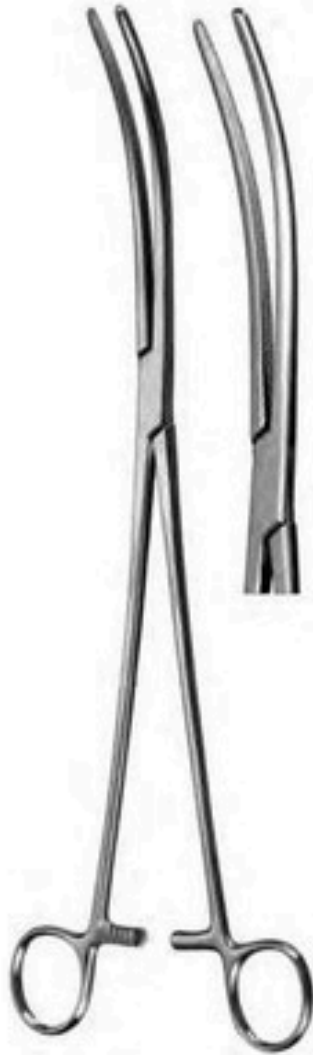

1950-340

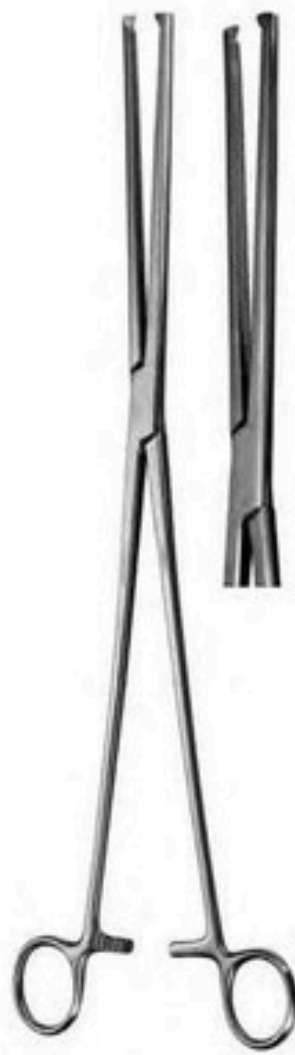

1950-350



1950-360

BARIATRIC SURGICAL INSTRUMENTS

- | | |
|----------|--|
| 1950-330 | ROCHESTER-PEAN Hemostatic Forceps, Straight, 14" (35.6 cm) |
| 1950-340 | ROCHESTER-PEAN Hemostatic Forceps, Curved, 14" (35.6 cm) |
| 1950-350 | ROCHESTER-OCHSNER Hemostatic Forceps, 1 x 2 Teeth, Straight, 14" (35.6 cm) |
| 1950-360 | ROCHESTER-OCHSNER Hemostatic Forceps, 1 x 2 Teeth, Curved, 14" (35.6 cm) |



1950-370



1950-380



1950-390

BARIATRIC SURGICAL INSTRUMENTS

- | | |
|----------|--|
| 1950-370 | GEMINI Forceps, Curved, 14" (35.6 cm) |
| 1950-380 | MAYO-HEGAR Needle Holder, T.C. Inlays, 14" (35.6 cm) |
| 1950-390 | CRILE-WOOD Needle Holder, T.C. Inlays, 14" (35.6 cm) |



1950-400
1950-405



1950-410

BARIATRIC SURGICAL INSTRUMENTS

- 1950-400 ALLIS Tissue Forceps, 4 x 5 Teeth, 14" (35.6 cm)
- 1950-405 ALLIS Tissue Forceps, 5 x 6 Teeth, 14" (35.6 cm)
- 1950-410 BABCOCK Intestinal Forceps, 14" (35.6 cm)



1950-415



1950-420



1950-430

BARIATRIC SURGICAL INSTRUMENTS

- 1950-415 Scalpel Handle #3, Fits Blades sizes 10-15
- 1950-420 MAYO Dissecting Scissors, Straight, T.C. Edges, 16" (40.6 cm)
- 1950-430 MAYO Dissecting Scissors, Curved, T.C. Edges, 16" (40.6 cm)



1950-440



1950-450



1950-460



1950-470

BARIATRIC SURGICAL INSTRUMENTS

- 1950-440 METZENBAUM Scissors, Curved, T.C. Edges, 16" (40.6 cm)
- 1950-450 Thumb Dressing Forceps, 16" (40.6 cm)
- 1950-460 Thumb Tissue Forceps, 1 x 2 Teeth, 16" (40.6 cm)
- 1950-470 DeBAKEY Tissue Forceps, 16" (40.6 cm)



1950-475



1950-480



1950-490

BARIATRIC SURGICAL INSTRUMENTS

- 1950-475 RUSSIAN Tissue Forceps, 16" (40.6 cm)
- 1950-480 ROCHESTER-PEAN Hemostatic Forceps, Straight, 16" (40.6 cm)
- 1950-490 ROCHESTER-PEAN Hemostatic Forceps, Curved, 16" (40.6 cm)



1950-500



1950-510



1950-520

BARIATRIC SURGICAL INSTRUMENTS

- 1950-500 ROCHESTER-OCHSNER Hemostatic Forceps, 1 x 2 Teeth, Straight, 16" (40.6 cm)
- 1950-510 ROCHESTER-OCHSNER Hemostatic Forceps, 1 x 2 Teeth, Curved, 16" (40.6 cm)
- 1950-520 GEMINI Forceps, Curved, 16" (40.6 cm)



1950-530



1950-532



1950-540

BARIATRIC SURGICAL INSTRUMENTS

- 1950-530 MAYO-HEGAR Needle Holder, T.C. Inlays, 16" (40.6 cm)
- 1950-532 MAYO-HEGAR Needle Holder, 16" (40.6 cm)
- 1950-540 CRILE-WOOD Needle Holder, T.C. Inlays, 16" (40.6 cm)



1950-550
1950-555



1950-560

BARIATRIC SURGICAL INSTRUMENTS

- 1950-550 ALLIS Tissue Forceps, 4 x 5 Teeth, 16" (40.6 cm)
- 1950-555 ALLIS Tissue Forceps, 5 x 6 Teeth, 16" (40.6 cm)
- 1950-560 BABCOCK Intestinal Forceps, 16" (40.6 cm)



1950-590



1950-595



1950-600



BARIATRIC SURGICAL INSTRUMENTS

- 1950-590 Thumb Dressing Forceps, 18" (45.7 cm)
- 1950-595 Thumb Tissue Forceps, 1 x 2 Teeth, 18" (45.7 cm)
- 1950-600 DeBAKEY Tissue Forceps, 18" (45.7 cm)



1950-605



1950-610

BARIATRIC SURGICAL INSTRUMENTS

- 1950-605 ROCHESTER-PEAN Hemostatic Forceps, Straight, 18" (45.7 cm)
- 1950-610 ROCHESTER-PEAN Hemostatic Forceps, Curved, 18" (45.7 cm)



1950-615



1950-620

BARIATRIC SURGICAL INSTRUMENTS

- 1950-615 ROCHESTER-OCHSNER Hemostatic Forceps, 1 x 2 Teeth, Straight, 18" (45.7 cm)
- 1950-620 ROCHESTER-OCHSNER Hemostatic Forceps, 1 x 2 Teeth, Curved, 18" (45.7 cm)



1950-625



1950-630



1950-632

BARIATRIC SURGICAL INSTRUMENTS

- 1950-625 GEMINI Forceps, Curved, 18" (45.7 cm)
- 1950-630 MAYO-HEGAR Needle Holder, T.C. Inlays, 18" (45.7 cm)
- 1950-632 MAYO-HEGAR Needle Holder, 18" (45.7 cm)



1950-645



1950-650

BARIATRIC SURGICAL INSTRUMENTS

1950-645 BABCOCK Intestinal Forceps, 18" (45.7 cm)

1950-650 RUSSIAN Tissue Forceps, 18" (45.7 cm)



134-961 Surgical Plate Str
Screw head 3.5mm
Shaft Screw 3.5mm
Hole 3 to 10 hole
Shaft Width 12mm
Head size 23mm



134-962 Surgical Plate Cvd
Screw head 5.0mm
Shaft Screw 4.5&5mm
Locking Screw
Hole 5 to 12hole
Shaft Width 16.5mm
Head size 22mm

***HOLLOWARE HEALTHCARE PRODUCTS
SURGICAL, LABORATORY AND
STAINLESS STEELWARE***





STORAGE CONTAINERS WITH COVER AND WITHOUT HANDLE

- | | | | |
|---------|--|--|-----------------------------------|
| 135-200 | Storage Container W/Cover and Without Handles, | 1 Qt. (1.18 L), | 4 9/16" x 5 3/4" (11.6 x 14.6 cm) |
| 135-202 | Storage Container W/Cover and Without Handles, | 2 Qt. 5 1/8" x 6 1/2" (13.8 x 16.8 cm) | |
| 135-204 | Storage Container W/Cover and Without Handles, | 3 1/4 Qt. (3.07 L), | 6 1/2" x 7" (16.5 x 17.8 cm) |
| 135-206 | Storage Container W/Cover and Without Handles, | 4 3/4 Qt. (4.49 L), | (18.8 x 20.3 cm) |
| 135-208 | Storage Container W/Cover and Without Handles, | 5.79 L), | 8" x 8 3/4" (20.3 x 22.2 cm) |
| 135-210 | Storage Container W/Cover and Without Handles, | 8 Qt. 8 7/8" x 11" (22.2 x 24 cm) | |
| 135-212 | Storage Container W/Cover and Without Handles, | 12 Qt. 9 1/2" x 13.85 L) | (24 x 27.9 cm) |



STORAGE CONTAINERS WITH COVER AND HANDLES

- | | | | |
|---------|--|---|--------------------------------|
| 135-214 | Storage Container W/Cover and Handles, | 8 Qt. 8 7/8" x 12 1/2" (24.8 x 19.4 cm) | |
| 135-216 | Storage Container W/Cover and Handles, | 12 Qt. 10 1/2" x 13.85 L) | (26.4 x 22.9 cm) |
| 135-218 | Storage Container W/Cover and Handles, | 16 Qt. (15.14 L), | 13" x 9" (33 x 22.9 cm) |
| 135-220 | Storage Container W/Cover and Handles, | 20 Qt. (18.92 L), | 13" x 11" (33 x 27.9 cm) |
| 135-222 | Storage Container W/Cover and Handles, | 24 Qt. (22.71 L), | 13" x 13" (33 x 33 cm) |
| 135-224 | Storage Container W/Cover and Handles, | 32 Qt. (30.28 L), | 15" x 12 1/2" (38.1 x 31.8 cm) |
| 135-226 | Storage Container W/Cover and Handles, | 40 Qt. (37.85 L), | 15" x 16" (38.1 x 40.6 cm) |



GRIFFIN STYLE BEAKERS

135-228	Griffin Style Beaker,	4.22 Oz.	(125 ml)	x 2 1/8" (5.4 x 6.7 cm)
135-230	Griffin Style Beaker,	8.45 Oz.	(250 ml)	x 3 1/8" (6.7 x 8.3 cm)
135-232	Griffin Style Beaker,	20.28 Oz.	(600 ml)	x 4 1/8" (8.6 x 11.8 cm)
135-234	Griffin Style Beaker,	40.57 Oz.	(1200 ml)	x 6 1/16" (10.5 x 15.4 cm)
135-236	Griffin Style Beaker,	67.62 Oz.	(2000 ml)	x 7 1/8" (12.4 x 18.1 cm)
135-238	Griffin Style Beaker,	101.44 Oz.	(3000 ml)	5 1/2" x 8 1/4" (14 x 20.9 cm)
135-240	Griffin Style Beaker,	135.25 Oz.	(4000 ml)	x 8 1/8" (15.5 x 20.6 cm)



SOLUTION PAILS

135-242	Solution Pail W/Cover,	13 Qt.	(12.30 L)	11 1/8" x 9 1/4" (29.5 x 23.5 cm)
135-244	Solution Pail W/Cover,	16 Qt.	(15.14 L)	x 10 1/8" (28.9 x 25.7 cm)
135-244A	Solution Pail W/Cover,	20 Qt.	(18.92 L)	x 10 1/8" (34.3 x 25.7 cm)



INSTRUMENT TRAYS WITH FLAT SOLID COVER - RECESSED STRAP

135-245	Instrument Tray With Cover,	8 1/2" x 5" x 2"	(21.6 x 12.7 x 5.1 cm)
135-245A	Instrument Tray With Cover,	12" x 7 3/4" x 2"	(30.5 x 19.4 x 5.1 cm)
135-246	Instrument Tray With Flat Cover,	12 1/4" x 7 3/4" x 2 1/4"	(31.1 x 19.7 x 5.7 cm)
135-248	Instrument Tray With Flat Cover,	10" x 8 1/4" x 2 1/2"	(25.4 x 20.9 x 6.4 cm)
135-250	Instrument Tray With Flat Cover,	10" x 8 1/4" x 4"	(25.4 x 20.9 x 10.2 cm)
135-252	Instrument Tray With Flat Cover,	16 1/2" x 10" x 2 1/2"	(41.9 x 25.4 x 6.4 cm)
135-254	Instrument Tray With Flat Cover,	16 1/2" x 10" x 4"	(41.9 x 25.4 x 10.2 cm)
135-256	Instrument Tray With Flat Cover,	12 1/4" x 12 1/4" x 2 1/2"	(35.2 x 32.7 x 6.4 cm)
135-258	Instrument Tray With Flat Cover,	12 1/4" x 12 1/4" x 4"	(35.2 x 32.7 x 10.2 cm)
135-259P	Inst. Pan Cover, Rounded Corners,	10" x 5 1/2"	(31.1 x 25.4 x 1.6 cm)
135-259C	Inst. Pan, Internal Dimension,	11 1/2" x 9 1/4" x 4"	(29.2 x 23.5 x 10.2 cm)



STERILIZATION TRAYS - BATH SETS (HOT/COLD)

135-260	Sterilization Tray, Solid,	20 3/4" x 12 3/4" x 4"	(52.7 x 32.4 x 10.2 cm)
135-262	Sterilization Tray, Perforated,	20 3/4" x 12 3/4" x 2 1/2"	(52.7 x 32.4 x 6.4 cm)
135-264	Sterilization Tray, Solid,	20 3/4" x 12 3/4" x 6"	(52.7 x 32.4 x 15.2 cm)
135-266	Sterilization Tray, Perforated,	20 3/4" x 12 3/4" x 4"	(52.7 x 32.4 x 10.2 cm)
135-268	Sterilization Tray, Solid,	12 3/4" x 10 3/8" x 4"	(32.4 x 26.4 x 10.2 cm)
135-270	Sterilization Tray, Perforated,	12 3/4" x 10 3/8" x 2 1/2"	(32.4 x 26.4 x 6.4 cm)
135-272	Sterilization Tray, Solid,	12 3/4" x 10 3/8" x 6"	(32.4 x 26.4 x 15.2 cm)
135-274	Sterilization Tray, Perforated,	12 3/4" x 10 3/8" x 4"	(32.4 x 26.4 x 10.2 cm)
135-276	Sterilization Trays, Flat Solid Covers, Fits 135-260 to 35-		
135-278	Sterilization Trays, Flat Solid Covers, Fits 135-268 to 35-		



BEDSIDE TRAYS

- 135-280 Bedside Tray, 10 $\frac{1}{2}$ " x 6 $\frac{3}{4}$ " (25.4 x 16.5 x 1.9 cm)
135-282 Bedside Tray, 13 $\frac{1}{16}$ " x 9 $\frac{1}{16}$ " x 3 $\frac{3}{4}$ " (34.8 x 24.9 x 1.9 cm).



STRAIGHT-SIDED PITCHERS

- 135-284 Straight-Sided Pitcher, 2 Qt. (1.893 L) x 6 $\frac{1}{2}$ " (13 x 16.8 cm)
135-286 Straight-Sided Pitcher, 3 Qt. (2.832 L) x 7" (15.7 x 17.8 cm)



TUMBLERS

- 135-288 Tumbler, 7 Oz. (207.01 ml) x 3 $\frac{1}{8}$ " (7.3 x 8 cm)
135-290 Tumbler, 12 Oz. (354.88 ml) x 4" (8 x 10.2 cm)



MAYO TRAYS PERFORATED WITH ROLLED BEAD

- 135-298 Mayo Perforated Tray, 10" x 6 1/2" x 3/4" (25.4 x 16.5 x 1.9 cm)
- 135-299 Mayo Perforated Tray, 13 1/2" x 9 3/4" x 3/4" (34.3 x 24.8 x 1.9 cm)
- 135-300 Mayo Perforated Tray, 15 1/2" x 10 5/8" x 3/4" (39.4 x 27 x 1.9 cm)
- 135-301 Mayo Perforated Tray, 17" x 11 5/8" x 3/4" (43.2 x 29.5 x 1.9 cm)
- 135-302 Mayo Perforated Tray, 19 1/2" x 12 5/8" x 3/4" (49.5 x 32.1 x 1.9 cm)
- 135-302A Mayo Perforated Tray, 21 1/4" x 16 1/4" x 3/4" (54 x 41.3 x 1.9 cm)



MAYO TRAYS OBLONG PERFORATED WITH ROLLED BEAD

- 135-303 Mayo Non-Perforated Tray, 10" x 6 1/2" x 3/4" (25.4 x 16.5 x 1.9 cm)
- 135-304 Mayo Non-Perforated Tray, 13 1/2" x 9 3/4" x 3/4" (34.3 x 24.8 x 1.9 cm)
- 135-305 Mayo Non-Perforated Tray, 15 1/2" x 10 5/8" x 3/4" (39.4 x 27 x 1.9 cm)
- 135-306 Mayo Non-Perforated Tray, 17" x 11 5/8" x 3/4" (43.2 x 29.5 x 1.9 cm)
- 135-307 Mayo Non-Perforated Tray, 19 1/2" x 12 5/8" x 3/4" (49.5 x 32.1 x 1.9 cm)
- 135-308 Mayo Non-Perforated Tray, 21 1/4" x 16 1/4" x 3/4" (54 x 41.3 x 1.9 cm)
- 135-308A Mayo Non-Perforated Tray, 25" x 15" x 5/8" (63.5 x 38.1 x 1.6 cm)
With Flat Flange



CATHETER TRAYS WITH DOME COVERS

- 135-309 Catheter Trays With Dome Covers, 8 3/4" x 3 1/4" x 1 1/2" (22.2 x 8.3 x 3.8 cm)
- 135-310 Catheter Trays With Dome Covers, 5 1/4" x 5" x 2" (22.5 x 12.7 x 5.1 cm)
- 135-311 Catheter Trays With Dome Covers, 5 1/4" x 5" x 3" (22.5 x 12.7 x 7.6 cm)
- 135-311A Catheter Trays With Dome Covers, 12 1/2" x 3 3/4" x 1 3/4" (31.8 x 9.5 x 4.5 cm)
- 135-312 Catheter Trays With Dome Covers, 17 1/4" x 4 1/2" x 2" (43.8 x 11.4 x 5.1 cm)



CATHETER TRAYS WITH ROUNDED COVER AND RECESSED STRAP

- 135-313 Catheter Tray With Rounded Cover, 12 3/4" x 7 3/4" x 2 1/4" (32.4 x 19.7 x 5.7 cm)
Recessed strap



HIGH-SIDED PERFORATED INSTRUMENTS TRAYS

- 135-314 Instrument Tray, High Sided, Perforated, 10 1/2" x 6 1/2" x 2" (22.5 x 12.7 x 5.1 cm)
- 135-315 Instrument Tray, High Sided, Perforated, 10" x 6 1/2" x 2" (25.4 x 16.5 x 5.1 cm)
- 135-316 Instrument Tray, High Sided, Perforated, 12 1/4" x 7 3/4" x 2 1/4" (31.1 x 19.7 x 5.7 cm)
- 135-317 Instrument Tray, High Sided, Perforated, 10 3/8" x 2 1/2" (32.4 x 26.4 x 6.4 cm)
- 135-318 Instrument Tray, High Sided, Perforated, 16 1/2" x 10" x 2 1/2" (42 x 25.4 x 6.4 cm)
- 135-318A Instrument Tray, High Sided, Perforated, 17 3/4" x 12 3/4" x 2 1/2" (45 x 32.4 x 6.4 cm)
- 135-319 Instrument Tray, High Sided, Perforated, 20 3/4" x 12 3/4" x 2 1/2" (52.7 x 32.4 x 6.4 cm)



HIGH-SIDED NON-PERFORATED INSTRUMENTS TRAYS

135-314NP	Inst. Tray, High Sided, Non-Perforation, 4 7/8" x 5" x 2" (22.5 x 12.7 x 5.1 cm)
135-315NP	Inst. Tray, High Sided, Non-Perforation, 10" x 6 1/2" x 2" (25.4 x 16.5 x 5.1 cm)
135-316NP	Inst. Tray, High Sided, Non-Perforation, 12 1/4" x 7 3/4" x 2 1/4" (31.1 x 19.7 x 5.7 cm)
135-317NP	Inst. Tray, High Sided, Non-Perforation, 12 1/2" x 8 1/2" x 1 1/4" (31.8 x 21.6 x 3.2 cm)

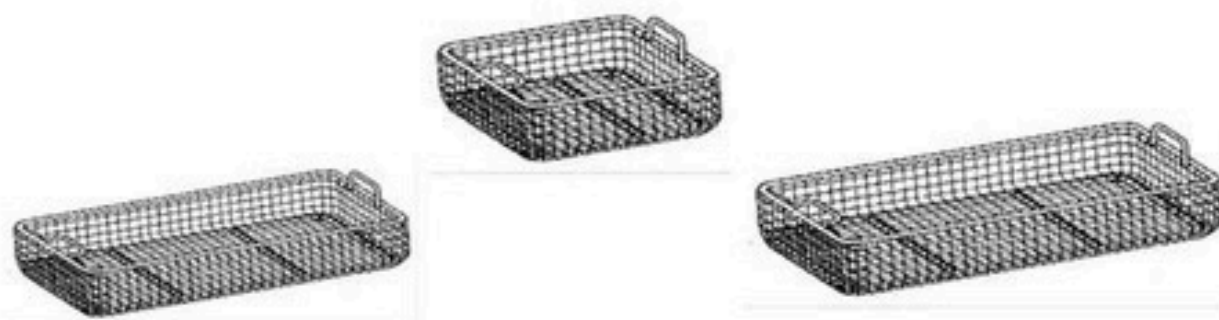

WIRE MESH STERILIZATION TRAYS

135-320	Wire Mesh Sterilization Tray, 9 7/16" x 9 7/32" x 1 3/32" (24 x 25 x 5 cm)
135-321	Wire Mesh Sterilization Tray, 9 7/16" x 9 7/32" x 2 3/4" (24 x 25 x 7 cm)
135-322	Wire Mesh Sterilization Tray, 9 7/16" x 10" x 1 3/32" (24 x 25.4 x 5 cm)
135-323	Wire Mesh Sterilization Tray, 11 1/4" x 9 27/32" x 1 3/32" (48 x 25 x 5 cm)
135-324	Wire Mesh Sterilization Tray, 11 1/4" x 9 27/32" x 2 3/4" (48 x 25 x 7 cm)
135-325	Wire Mesh Sterilization Tray, 11 1/4" x 9 27/32" x 3 9/16" (48 x 25 x 10 cm)
135-326	Wire Mesh Sterilization Tray, 11 1/4" x 10" x 1 3/32" (48 x 25.4 x 5 cm)
135-327	Wire Mesh Sterilization Tray, 12 1/16" x 10" x 1 3/32" (51 x 25.4 x 5 cm)
135-328	Wire Mesh Sterilization Tray, 9 7/16" x 9 7/32" x 2 3/8" (24 x 25 x 6 cm)
135-329	Wire Mesh Sterilization Tray, 11 1/4" x 9 27/32" x 2 3/8" (48 x 25 x 6 cm)



BED PANS

- 135-330 Bed Pan, Adult Size, 13 3/4" x 11 1/2" x 4" (34.9 x 29.2 x 10.2 cm)
 135-333 Bed Pan, Child Size, 12 1/8" x 9 3/4" x 3" (30.8 x 24.8 x 7.6 cm)



FRACTURED BED PANS

- 135-335 Fractured Bed Pan, 11 1/8" x 9 1/2" x 2 1/8" (30.1 x 24.1 x 7.3 cm)



MALE AND FEMALE URINALS

- 135-336 Male Urinal Vertical/Horizontal, 1 3/4 Qt. (4.65 L) 9 1/2" (11.4 x 23.2 cm)
 135-337 Male Urinal-Vertical Only, 1 1/2 Qt. (4.2 L) 9 1/2" (11.4 x 23.2 cm)
 135-337F Female Urinal, 0.64 Qt. (0.51 L) 8 3/4" (14 x 22.2 cm)



EMESIS BASINS, KIDNEY TRAYS, DEEP WITHOUT COVER

135-338	Emesis Basin, Small,	1029.73 ml),	6 1/8" x 3 1/2" x 1 1/2"	(16.8 x 8.9 x 3.8 cm)
135-339	Emesis Basin, Medium,	1234.88 ml),	8 1/8" x 3 3/8" x 1 1/2"	(20.6 x 9.2 x 4.1 cm)
135-340	Emesis Basin, Large,	2678.91 ml),	9 1/8" x 4 1/2" x 2 1/8"	(25 x 11.4 x 5.4 cm)
135-341	Emesis Basin, X/Large,	4819.53 ml),	12" x 5 1/2" x 2 3/8"	(30.5 x 14 x 6.1 cm)



FORCEPS, THERMOMETER AND APPLICATOR JARS

135-342	Forceps Jar, Small,	2 1/4" x 4 1/4"	(5.7 x 10.8 cm)
135-343	Forceps jar, Large,	2 1/4" x 7"	(5.7 x 17.8 cm)
135-344	Applicator Jar With Slip Cover,	28 Oz	(828 ml), 3 1/8" x 7" (8 x 17.8 cm)



SOAP DISH - SYRINGE STERILIZER

135-347 Soap Dish/Syringe Sterilizer, 6 1/4" x 4 1/8" x 1 1/8" (14 x 10.5 x 2.9 cm)



WASH BASINS

135-348 Wash Basin, 4 Qt. (3.78 l), 11 1/8" x 3 3/4" (31.5 x 9.5 cm)

135-349 Wash Basin, 1/2 Qt. (4.62 ml), 13 1/4" x 3 1/2" (33.7 x 8.9 cm)



IODINE CUPS

135-350 Iodine Cups, Small, 6 Oz. (177.44 ml), 8 1/2" x 2" (8.7 x 5.1 cm)

135-355 Iodine Cups, Large, 14 Oz. (414.02 ml), 11 1/2" x 2 1/2" (12.1 x 6.7 cm)



NEEDLE STERILIZING CASES

- 135-357 Needle Sterilizing Case, Round Dia. 6.5 x 1.5 cm Height, W/Perforated Inner Case.
135-358 Inner Case Only Perforated



MEDICINE CUP-GRADUATED

- 135-360 Medicine Cup, Graduated, 2 Oz. (59.24 ml) (5.4 x 5.1 cm)



MEASURING BEAKERS

- 135-362 Measuring Beaker, Graduated, (170 ml), 3 3/4" x 4 1/2" (9.5 x 11.8 cm)
135-365 Measuring Beaker, Graduated, 32 Oz. (946.35 ml), 4 3/4" x 5 1/4" (12.1 x 13.3 cm)
135-368 Measuring Beaker, Graduated, 64 Oz. (1892.71 ml), 5 1/2" x 6 1/2" (14 x 16.5 cm).



TRANSFER FORCEPS

135-369 Transfer Forceps, Pistol Grip, Stainless Steel



KICK BUCKETS AND STAND STAINLESS STEEL

- 135-370** Kick Bucket With Roll Stand Set, 13 Qt (12.30 L)
135-370A Kick Bucket With Roll Stand Set, 16 Qt (15.14.L)
135-370B Kick Bucket Roll Stand Only
135-370D Kick Bucket Only, 13 Qt (12.30 L), 11 3/4" x 9 1/4" (29.9 x 23.5 cm)
 11 3/4" x 10 1/2" (29.9 x 25.7 cm)
135-370E Kick Bucket Only, 20 Qt. (18.92 L), 18 1/2" x 15" (46.7 x 38.1 cm)



OINTMENT JARS WITH SLIP-OVER COVER

- 135-371** Ointment Jar With Strap Handle Cover, 9 Oz. (266310) 8 x 7 cm
135-372 Ointment Jar With Plain Cover, 9 Oz. (266310) 8 x 7 cm



SOLUTION BASINS

- 135-375 Solution Basin, Heavy Gauge, 5 Qt. (4.7 L), 12" x 4 1/4" x 11 1/4" (30.5 x 10.8 x 28.5 cm)
- 135-376 Solution Basin, Heavy Gauge, 6 Qt. (5.3 L), 12 1/4" x 4 3/8" x 11 1/8" (31.1 x 11.1 x 30.1 cm)
- 135-377 Solution Basin, Heavy Gauge, 7 Qt. (6.6 L), 13 1/4" x 4 1/2" x 13 1/8" (34.6 x 11.7 x 33.3 cm)
- 135-378 Solution Basin, Heavy Gauge, 8 1/2 Qt. (8.1 L), 14 1/4" x 4 3/4" x 13 1/8" (36.8 x 12 x 35.2 cm)



SPONGE BOWLS

- 135-382 Sponge Bowl, 22 Oz. (650.68 ml), 4 1/4" x 2" (10.8 x 5.1 cm)
- 135-383 Sponge Bowl, 29 Oz. (857.63 ml), 5" x 2 3/8" (12.7 x 6.1 cm)
- 135-384 Sponge Bowl, 38 Oz. (1094.53 ml), 6 1/4" x 2 3/4" (15.9 x 7 cm)
- 135-386 Sponge Bowl, 64 Oz. (1892.71 ml), 7 1/8" x 2 3/4" (18 x 7 cm)



DRESSING JARS WITH SLIP-OVER COVERS

- 135-390 Dressing Jars with Slip Over Cover, 1/2 Qt. (0.47 L), 4 1/2" x 5 7/8" (10.5 x 5.7 cm)
- 135-391 Dressing Jars with Slip Over Cover, 1 1/4 Qt. (1.18 L), 4 1/2" x 11 1/8" (10.5 x 14 cm)
- 135-392 Dressing Jars with Slip Over Cover, 1 Qt. (1.77 L), 4 3/4" x 6 1/4" (12.3 x 15.9 cm)
- 135-393 Dressing Jars with Slip Over Cover, 3 Qt. (2.83 L), 5 1/8" x 14 1/8" (14.9 x 17.1 cm)
- 135-394 Dressing Jars with Slip Over Cover, 4 3/4 Qt. (4.49 L), 6 3/4" x 7 3/4" (17.1 x 19.7 cm)
- 135-395 Dressing Jars with Slip Over Cover, 6 Qt. (5.67 L), 7 1/8" x 18 1/8" (18.4 x 21.3 cm)
- 135-396 Dressing Jars with Slip Over Cover, 8 Qt. (7.57 L), 8 1/8" x 23 9/16" (20.3 x 23.9 cm)



SURGICAL BOXES STAINLESS STEEL WITHOUT KNOB

135-406	Surgical Box With Cover, Without Knob,	7" x 3" x 1 1/2"	(17.8 x 7.6 x 3.8 cm).
135-406A	Surgical Box With Cover, Without Knob,	8" x 3 1/2" x 1 1/2"	(20.3 x 8.9 x 3.8 cm)
135-407	Surgical Box With Cover, Without Knob,	8" x 4" x 2"	(20.3 x 10.2 x 5.1 cm)
135-407A	Surgical Box With Cover, Without Knob,	9" x 5" x 2"	(22.9 x 12.7 x 5.1 cm)
135-408	Surgical Box With Cover, Without Knob,	10" x 4" x 2"	(25.4 x 10.2 x 5.1 cm)
135-409	Surgical Box With Cover, Without Knob,	10" x 5" x 2"	(25.4 x 12.7 x 5.1 cm)
135-410	Surgical Box With Cover, Without Knob,	12" x 6" x 2"	(30.5 x 15.2 x 5.1 cm)
135-411	Surgical Box With Cover, Without Knob,	12" x 6" x 3"	(30.5 x 15.2 x 7.6 cm)
135-506	Surgical Box With Cover, Without Knob,	13" x 6" x 2"	(33 x 15.2 x 5.1 cm)
135-506A	Surgical Box With Cover, Without Knob,	13 1/2" x 6 1/2" x 2 1/2"	(34.2 x 16.5 x 6.4 cm)
135-506B	Surgical Box With Cover, Without Knob,	13 1/2" x 8" x 5"	(34.2 x 20.3 x 12.7 cm)
135-507	Surgical Box With Cover, Without Knob,	14" x 6" x 3"	(35.6 x 15.2 x 7.6 cm)
135-508	Surgical Box With Cover, Without Knob,	12" x 8" x 2"	(30.5 x 20.3 x 5.1 cm)
135-509	Surgical Box With Cover, Without Knob,	16" x 8" x 4"	(40.6 x 20.3 x 10.2 cm)
135-510	Surgical Box With Cover, Without Knob,	18" x 8" x 4"	(45.7 x 20.3 x 10.2 cm)
135-511	Surgical Box With Cover, Without Knob,	20" x 8" x 4"	(50.8 x 20.3 x 10.2 cm)



SURGICAL BOXES STAINLESS STEEL WITH KNOB

135-412	Surgical Box With Cover, With Knob,	7" x 3" x 1 1/2"	(17.8 x 7.6 x 3.8 cm)
135-414	Surgical Box With Cover, With Knob,	8" x 3 1/2" x 2"	(20.3 x 8.9 x 5.1 cm).
135-416	Surgical Box With Cover, With Knob,	10" x 4" x 2"	(25.4 x 10.2 x 5.1 cm)
135-418	Surgical Box With Cover, With Knob,	12" x 5" x 2"	(30.5 x 12.7 x 5.1 cm).
135-420	Surgical Box With Cover, With Knob,	12" x 6" x 3"	(30.5 x 15.2 x 7.6 cm).



SYSTEMS

of quality

GENERAL SURGICAL



DRESSING DRUMS

135-425	Dressing Drum, Horizontal Ventilation,	6" x 6"	(15.2 x 15.2 cm)
135-426	Dressing Drum, Horizontal Ventilation,	7" x 7"	(17.8 x 17.8 cm)
135-427	Dressing Drum, Horizontal Ventilation,	9" x 4 1/2"	(22.9 x 11.4 cm)
135-428	Dressing Drum, Horizontal Ventilation,	9" x 9"	(22.9 x 22.9 cm)
135-429	Dressing Drum, Horizontal Ventilation,	9" x 6"	(22.9 x 15.2 cm)
135-430	Dressing Drum, Horizontal Ventilation,	11" x 9 3/4"	(27.9 x 24.8 cm)
135-431	Dressing Drum, Horizontal Ventilation,	12" x 10"	(30.5 x 25.4 cm)
135-432	Dressing Drum, Horizontal Ventilation,	14" x 10"	(35.6 x 25.4 cm)
135-433	Dressing Drum, Horizontal Ventilation,	15" x 12"	(38.1 x 30.5 cm)
135-434	Dressing Drum, Non-Ventilated,	4" x 4"	(10.2 x 10.2 cm)
135-435	Dressing Drum, Non-Ventilated,	4" x 4 3/4"	(10.2 x 12.1 cm)
135-436	Dressing Drum, Non-Ventilated,	6" x 4 3/4"	(15.2 x 12.1 cm)
135-437	Dressing Drum, Non-Ventilated,	7 3/4" x 5 1/2"	(19.7 x 14 cm)



SYSTEMS

of quality

GENERAL SURGICAL



GALLIPOTS J-TYPE

135-450	Gallipot J-Type,	2 Oz.	(59.14 ml)
135-452	Gallipot J-Type,	3 Oz.	(88.72 ml)
135-454	Gallipot J-Type,	4 Oz.	(118.29 ml)
135-456	Gallipot J-Type,	6 Oz.	(177.44 ml)
135-458	Gallipot J-Type,	8 Oz.	(236.58 ml)
135-460	Gallipot J-Type,	10 Oz.	(295.73 ml)
135-462	Gallipot J-Type,	12 Oz.	(354.88 ml)



MIXING-SOLUTION BOWLS

135-464	Mixing Solutions Bowl,	$\frac{1}{4}$ Qt. (0.82 L),	6 $\frac{3}{8}$ " x 2 $\frac{1}{2}$ "	(16.8 x 6.4 cm)
135-466	Mixing Solutions Bowl,	$\frac{1}{2}$ Qt. (1.53 L),	8 $\frac{1}{8}$ " x 3"	(20.6 x 7.6 cm)
135-468	Mixing Solutions Bowl,	3 Qt. (2.83 L),	9 $\frac{3}{4}$ " x 4"	(24.8 x 10.2 cm)
135-470	Mixing Solutions Bowl,	5 Qt. (4.73 L),	11 $\frac{1}{8}$ " x 4 $\frac{1}{2}$ "	(30.1 x 11.4 cm)
135-472	Mixing Solutions Bowl,	6 $\frac{3}{4}$ Qt. (6.38 L),	12 $\frac{3}{4}$ " x 5 $\frac{1}{4}$ "	(32.4 x 13.3 cm)
135-474	Mixing Solutions Bowl,	8 Qt. (7.57 L),	13 $\frac{1}{8}$ " x 5 $\frac{1}{16}$ "	(33.8 x 13.8 cm)
135-476	Mixing Solutions Bowl,	13 $\frac{1}{2}$ Qt. (12.77 L),	16 $\frac{1}{4}$ " x 6"	(41.2 x 15.2 cm)



JAR COVERS

- | | | |
|----------------|---------------------------------------|-----------------------------|
| 135-480 | Jar Cover, Diameter $2\frac{7}{8}$ " | (7.3 cm) |
| | | $3\frac{47}{64}$ " (9.5 cm) |
| 135-482 | Jar Cover, Diameter $4\frac{1}{4}$ " | (10.6 cm) |
| 135-484 | Jar Cover, Diameter $4\frac{1}{16}$ " | (11.9 cm) |
| 135-486 | Jar Cover, Diameter $5\frac{1}{8}$ " | (14.3 cm) |



IRRIGATORS WITH HANDLES

- | | | |
|----------------|------------------------|-------------------|
| 135-700 | Irrigator with Handle, | 1.05 Qt. (1 L) |
| 135-702 | Irrigator with Handle, | 1.50 Qt. (1.58 L) |
| 135-704 | Irrigator with Handle, | 2 Qt. (2.11 L) |



SPITTING MUG WITH LID

- | | | |
|----------------|--------------------|--|
| 135-706 | Spitting Mug W/Lid | 12 Oz. (354.88 mL), x $1\frac{49}{64}$ " (10 x 4.5 cm) |
|----------------|--------------------|--|



PLACENTA PANS

- 135-712 Placenta Dish with Cover.
- 135-714 Placenta Dish without Cover



INSTRUMENT TROLLEY-UTILITY CARTS, ROLLING CARTS THREE SHELVES

- 135-720 Instrument Trolley Utility Cart, Small, 75 cm L. x 50 cm W. x 90 cm H.
- 135-722 Instrument Trolley Utility Cart, Medium, 91 cm L. x 57 cm W. x 110 cm H.
- 135-723 Instrument Trolley Utility Cart, Large, 91 cm L. x 52 cm W. x 120 cm H.



MORE INFORMATION:

 +92 321 610 1708

 www.systemsofquality.com

 SIALKOT-PAKISTAN

 systemsofquality@gmail.com